

UV LIGHT METER Instruction Manual

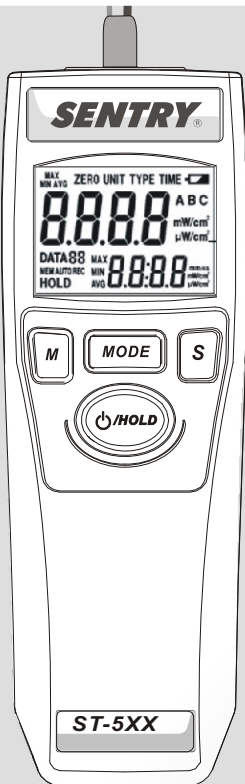

UV LIGHT METER

Instruction Manual

Storage for sensor

UV sensor is with extremely precise structure. Once don't use it, be sure it in the dry environment. Manual for future reference.

Danger when using the equipment



ATTENTION

Improper use endangers the health of third parties! It may also result in damage to the equipment or other material damage.

Table Content

1. General Information	1
2. Features	1
3. Safety Symbols	2
4. Specification	3
5-1 Control Panel	4
5-2 LCD Display	5
6. Operations of Instrument	6

1. General Information

Thank you for purchasing the ultraviolet meter. Read through this instruction manual before operating the unit. Please also store and retain this instruction manual for future reference.

2. Features

The UV-Meter is a mobile, hand-held device for measuring UV irradiation.

- Socket of tripod mounting.
- High and Low measurements range in a unit mW/cm^2 or $\mu\text{W}/\text{cm}^2$.
- Backlit LCD and 4 Digits dual display.
- 20 points memory.
- Automatic measuring.
- Low battery indicator.
- Operation with 9V battery.
- Magnetic mount.

3. Safety Symbols

 Indicates CE conformity



The device may not be disposed with the trash. It promotes the re-use recycling and other forms of recovery of used materials and components, and improves the environmental performance of all operators (manufacturers, traders and treatment facilities) involved in the life cycle of products. Dispose of the product appropriately in accordance with the regulations in force in your Country.

4. Specification

Over Range	Indication ' -HI- '
Zero Adjust	Yes
Auto Record	Yes
Sample Time	Approx. 0.3 sec
Display	Backlit LCD and Dual Display
Memory	20 points and 1 for interval time
Operation Temperature	0~50°C (32 ~122°F), 10~90%RH
Battery Type	9V (006P,IEC6F22,NEDA1604)
Weight	Approx. 90g without battery and detector.
Dimensions	140x49x29mm (5.51x 1.93 x 1.14inch)
Accessory	9V Battery , UV sensor probe , Instruction manual.

5-1 Control Panel

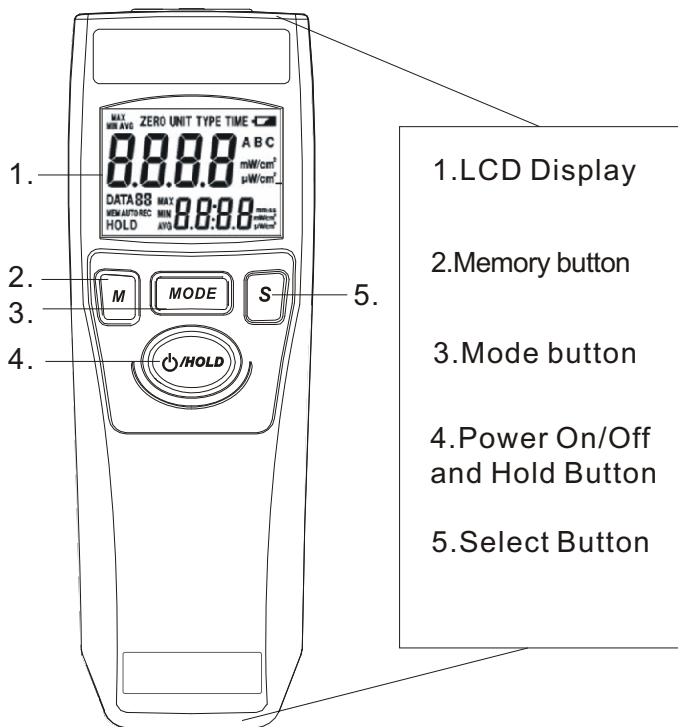

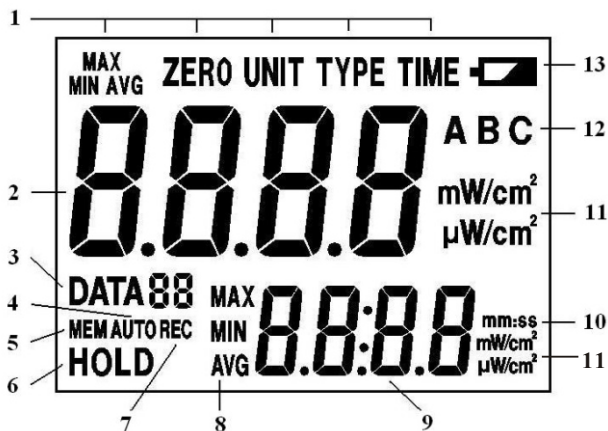

5-2 LCD Display





- | | |
|--------------------|----------------------|
| 1. Main Functions | 8. MAX/MIN/AVG |
| 2. Primary Reading | 9. Secondary Reading |
| 3. Data Log | 10. Time Unit |
| 4. Auto Mode | 11. Unit |
| 5. Memory Review | 12. UV Type |
| 6. Data Hold | 13. Low Battery |
| 7. Record | |

6. Operations of Instrument

Power On

Press  button and hold for 2 seconds. Release the  button after power on. All symbols of LCD will appear for 1 second.

Power Off

Press  button and hold for 2 seconds. All symbols of LCD will appear and shut down after releasing  button.

Measurement Value

The primary reading always displays value of measuring. The secondary reading displays the outcomes of the advanced functions or data recording.

Main Function

Press Mode button to choose the main functions (MAX/MIN/AVG has several extended programs as indicated in the diagram, please read the following descriptions to know how to press S,  or M buttons to move to next level!)

Main Function diagram

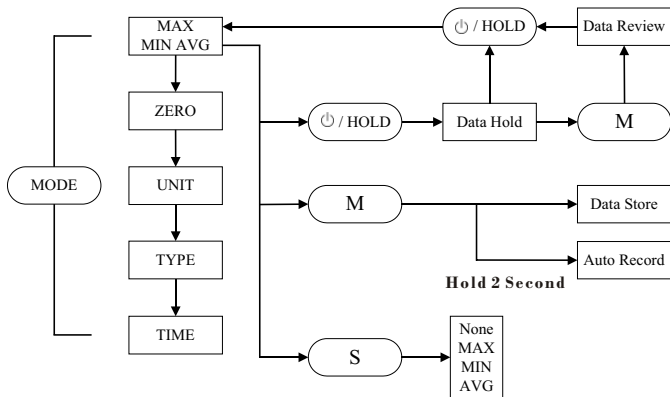

MAX MIN AVG

Max/Min/Avg Measuring Function

There are 4 modes of the measuring function. Press S button to change the mode of measuring: None → Max → Min → Avg.



Data Hold

Press  button, the value at Secondary Display will be held and the LCD will show HOLD symbol. To cancel hold mode, press the button again.

Data Review

Press M button during the hold mode, it will get into the data memory review mode. The LCD will show  symbol.

Press S button to review data 0 to 20. Data 0 is always stored the interval time after auto recording activated. If the data are automatically recorded, the AUTO symbol appears next to MEM during the review.

Data Store

Normal

Press M button to store the current measurement displayed at Primary Display. The flashing DATA(01~20) icon becomes steady for 2 seconds, and moves to next storage location.

Auto

If automatically recording is required, press M button and hold for 2 seconds. The LCD will show AUTO symbol next to REC symbol. As soon as it reaches 20 data, the system will turn off.

The following record contents will be stored:

- 1. Irradiation intensity**
- 2. Maximum, Minimum, Average or none**
- 3. Unit**

To cancel auto record mode, press M button again.

ZERO

Zero Adjust

Cover the sensor and press S button to zero adjust. The Secondary Display will display adjust value*. Press S button again and hold for 1 second to clear the adjust value.

**When the adjust value is over the range. The Secondary display will display “-Err”. Please follow the zero adjust step and do it again, or contact the distributor.*

Memory Clear

In Zero Mode, press M button to clear data 0 to 20.

UNIT

Unit Function

Press S button to change the unit, $\mu\text{W}/\text{cm}^2$ or mW/cm^2

TYPE

Type Function

(Only for wide range models, which cover two or more sensors.)

Press S button to set UV sensor spectrum.

TIME

Time Function

Press S button to set the interval time of auto recording.

This function allows to set 9 different time intervals by pressing S button.

The 9 time intervals are: 1, 2, 5, 10, 30 second or 1, 3, 5, 10 minutes.

Maintenance

Clean the housing: Use soap and water on a damp sponge or soft cloth. Care should be taken to prevent any liquids or moisture to get inside the unit.



When the battery is low, the battery symbol will display.

UVA SENSOR

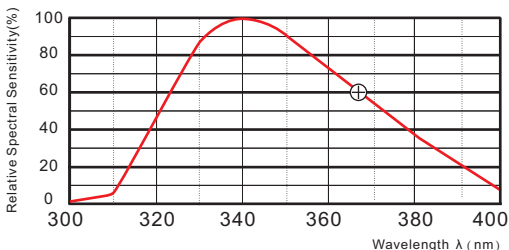

Specification

Sensor designation	UVA
Spectrum range	320~380 nm
Calibration point ⊕	365 nm
Temperature range	0° ~50°C
Accuracy(23±5°C)	±4% ±1 digit
Units/multi-ranges	
Low illumination	1 μW/cm ² ~9999 μW/cm ²
High illumination	0.01 mW/cm ² ~40.00 mW/cm ²

Note: Press "Mode" key to enter Unit selection mode.

Surface sensor



ATTENTION

The sensors are only suitable for short term measurement in a splash-proof environment, as otherwise premature aging and thermal destruction of the sensor will occur. The housing temperature must never exceed 50°C!

Dimensions

Ø= 35mm H= 25.5mm

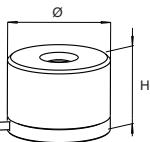

Extendable Wand

(A)

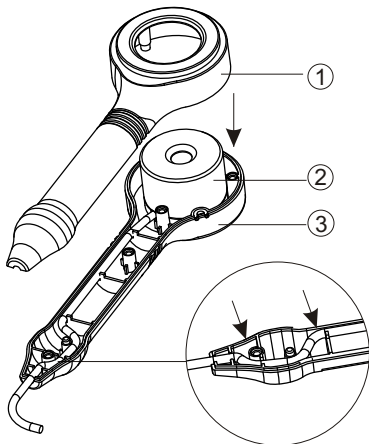

(B)

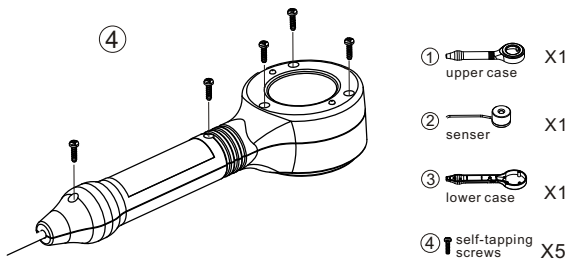

Note:

Recommend not to assemble and disassemble too many time to avoid the wear of screw holes .

SENTRY®

SENTRY OPTRONICS CORP.

3F, No.122, Sec.1, Sanmin Road,
Ban-Ciao, Taipei 220, Taiwan, R.O.C.

TEL:886-2-2956-8198

FAX:886-2-2956-7662

<http://www.sentrytek.com.tw>

PA05-0000512-01

ST 512 . Version-01 07/SEP.