

User Manual

SDS1000 Series Digital oscilloscope

UM0101X-E01A



2015 SIGLENT TECHNOLOGIES CO., LTD.

Copyright and Declaration

Copyright

SIGLENT TECHNOLOGIES CO., LTD. All Rights Reserved.

Trademark Information

SIGLENT is the registered trademark of **SIGLENT TECHNOLOGIES CO., LTD.**

Declaration

SIGLENT products are protected by patent law in and outside of P.R.C.

SIGLENT reserves the right to modify or change parts of or all the specifications or pricing policies at company's sole decision.

Information in this publication replaces all previously corresponding material.

Any way of copying, extracting or translating the contents of this manual is not allowed without the permission of **SIGLENT**.

Product Certification

SIGLENT guarantees this product conforms to the national and industrial stands in China and other international stands conformance certification is in progress.

Contact Us

If you have any problem or requirement when using our products, please contact

SIGLENT TECHNOLOGIES CO., LTD

Add: 3//F, Bldg No.4, Antongda Industrial Zone, 3rd Liuxian Road, Bao'an District, Shenzhen, 518101, P.R.China

Tel: 400-878-0807

E-mail: sales@siglent.com

<http://www.siglent.com>

Safety Information

General Safety Summary

Carefully read the following safety precautions to avoid any personal injury or damage to the instrument and any products connected to it. To avoid potential hazards, please use the instrument as specified.

Use Proper Power Line

Only the power cord designed for the instrument and authorized by local country could be used.

Ground the Instrument

The instrument is grounded through the protective earth conductor of the power line. To avoid electric shock, please make sure the instrument is grounded correctly before connecting its input or output terminals.

Connect the Signal Wire Correctly

The potential of the signal wire is equal to the earth, so do not connect the signal wire to a high voltage.

Look Over All Terminals' Ratings

To avoid fire or electric shock, please look over all ratings and sign instruction of the instrument. Before connecting the instrument, please read the manual carefully to gain more information about the ratings.

Use Proper Overvoltage Protection

Make sure that no overvoltage (such as that caused by a thunderstorm) can reach the product, or else the operator might expose to danger of electrical shock.

Electrostatic Prevention

Operate in an electrostatic discharge protective area environment to avoid damages induced by static discharge. Always ground both the internal and external conductors of the cable to release static before connecting.

Keep Well Ventilation

Inadequate ventilation may cause increasing of temperature, which will eventually damage the instrument. So keep well ventilation and inspect the intake and fan regularly.

Avoid Circuit or Components Exposed

Do not touch exposed contacts or components when the power is on.

Use proper Fuse

Use only the specified fuse.

Do Not Operate Without Covers

Do not operate the instrument with covers or panels removed.

Do Not Operate With Suspected Failures.

If you suspect damage occurs to the instrument, have it inspected by qualified service personnel before further operations. Any maintenance, adjustment or replacement especially to circuits or accessories must be performed by **SIGLENT** authorized personnel.

Do Not Operate in Wet Conditions.

In order to avoid short circuiting to the interior of the device or electric shock, please do not operate in a humid environment.

Do Not Operate in an Explosive Atmosphere.

In order to avoid damages to the device or personal injuries, it is important to operate the device away from an explosive atmosphere.

Keep Product Surfaces Clean and Dry.

To avoid the influence of dust and/or moisture in air, please keep the surface of device clean and dry.

Handling Safety

Please handle with care during transportation to avoid damages to buttons, knob interfaces and other parts on the panels.

Safety Terms and Symbols

Terms in this Manual. These terms may appear in this manual:

**WARNING**

Warning statements indicate the conditions or practices that could result in injury or loss of life.

**CAUTION**

Caution statements indicate the conditions or practices that could result in damage to this product or other property.

Terms on the product. These terms may appear on the product:

DANGER Indicates direct injuries or hazards that may happen.

WARNING Indicates potential injuries or hazards that may happen.

CAUTION Indicates potential damages to the instrument or other property that may happen.

Symbols on the product. These symbols may appear on the product:



**Hazardous
Voltage**



**protective Earth
Terminal**



Warning



**Test
Ground**



Power Switch

Measurement Category

Measurement Categories

SDS1000X series digital oscilloscopes can make measurements in measurement category I.



WARNING

This oscilloscope can only be used for measurements within its specified measurement categories.

Measurement Category Definitions

Measurement category I is for measurements performed on circuits not directly connected to MAINS. Examples are measurements on circuits not derived from MAINS, and specially protected (internal) MAINS derived circuits. In the latter case, transient stresses are variable; for that reason, the transient withstand capability of the equipment is made known to the user.

Measurement category II is for measurements performed on circuits directly connected to the low voltage installation. Examples are measurements on household appliances, portable tools and similar equipment.

Measurement category III is for measurements performed in the building installation. Examples are measurements on distribution boards, circuit-breakers, wiring, including cables, bus-bars, junction boxes, switches, socket-outlets in the fixed installation, and equipment for industrial use and some other equipment, for example. Stationary motors with permanent connection to the fixed installation.

Measurement category IV is for measurements performed at the source of the low-voltage installation. Examples are electricity meters and measurements on primary over current protection devices and ripple control units.

Working Environment

Temperature

Operating: 10°C to +40°C

Non-operation: -20°C to +70°C

Humidity

Under +35°C: ≤90% relative humidity

+35°C to +40°C: ≤60% relative humidity



WARNING

To avoid short circuit inside the instrument or electric shock, please do not operate in humid environment.

Altitude

Operating: less than 3 Km

Non-operation: less than 15 Km

Installation (overvoltage) Category

This product is powered by mains conforming to installation (overvoltage) category II.



WARNING

Make sure that no overvoltage (such as that caused by thunderbolt) can reach the product, or else the operator might expose to danger of electric shock.

Installation (overvoltage) Category Definitions

Installation (overvoltage) category I refers to signal level which is applicable to equipment measurement terminals connected to the source circuit. In these terminals, precautions are done to limit the transient voltage to the corresponding low level.

Installation (overvoltage) category II refers to the local power distribution level which is applicable to equipment connected to the AC line (AC power).

Ventilation Requirement

This oscilloscope uses fan to force cooling. Please make sure that the air intake and exhaust areas are free from obstructions and have free air. When using the oscilloscope in a bench-top or rack setting, provide at least 10 cm clearance beside, above and behind the instrument for adequate ventilation.

**WARNING**

Inadequate ventilation may cause temperature increase which would damage the instrument. So please keep the instrument well ventilated during operation and inspect the intake and fan regularly.

General Care and Cleaning

Care

Do not store or leave the instrument in direct sunshine for long periods of time.



WARNING

To avoid damages to the instrument or probe, please do not leave them in fog, liquid, or solvent.

Cleaning

Please perform the following steps to clean the instrument and probe regularly according to its operating conditions.

1. Disconnect the instrument from all power sources, and then clean it with a soft wet cloth.
2. Clean the loose dust on the outside of the instrument and probe with a soft cloth. When cleaning the LCD, take care to avoid scarifying it.



WARNING

To avoid damages to the surface of the instrument and probe, please do not use any corrosive liquid or chemical cleanser.



WARNING

Make sure that the instrument is completely dry before restarting it to avoid short circuits or personal injuries.

Document Overview

This manual introduces how to use SDS1000X series digital oscilloscope in details.

Quick Start	Provide information about preparations before using the instrument and a brief introduction of the instrument.
To Set the Vertical System	Introduce the functions of the vertical system of the oscilloscope.
To Set the Horizontal System	Introduce the functions of the horizontal system of the oscilloscope.
To Set the Sample System	Introduce the functions of the sample system of the oscilloscope.
To Trigger the Oscilloscope	Introduce the trigger mode, trigger coupling, trigger hold off, external trigger and various trigger types of the oscilloscope.
Serial Trigger and Decode	Introduce how to trigger and decode the input signal.
To Save Reference Waveform	Introduce how to save and display REF waveform.
To Make Math Operation	Introduce the math operation function of the oscilloscope.
To Make Cursor Measurements	Introduce how to use cursors to make measurements.
To Make Measurements	Introduce how to use measure function to measure the waveform parameters.
Display Setting	Introduce how to set the display of the oscilloscope.
Save and Recall	Introduce how to save and recall the measurement result and the setting of the oscilloscope.
System Setting	Introduce how to set the system setup.
Arbitrary Waveform Generation	Introduce how to use Arbitrary waveform generation function.
Default	Introduce the Default setup of the oscilloscope
Troubleshooting	Introduce how to deal with common failures of the oscilloscope.

Content Conventions in this Manual:

This manual takes SDS1202X-S for example and the descriptions here have contained all the functions and performances of other models. SDS1000X series includes the following models:

Model	Analogy Bandwidth	channels	AWG
SDS1102X	100MHz	2	N
SDS1102X-S	100 MHz	2	Y
SDS1202X	200 MHz	2	N
SDS1202X-S	200 MHz	2	Y

Table of Content

Copyright and Declaration	I
Safety Information	II
General Safety Summary	II
Safety Terms and Symbols	IV
Measurement Category	V
Working Environment	VI
Ventilation Requirement.....	VII
General Care and Cleaning.....	VIII
Document Overview.....	IX
Quick Start.....	1
General Inspection	2
Appearance and Dimensions	3
To Prepare the Oscilloscope for Use	4
To Adjust the Supporting Legs	4
To Connect to Power Supply	5
Power-on Inspection	6
To Connect the Probe	7
Function Inspection	8
Probe Compensation	9
Front Panel Overview	10
Rear Panel Overview.....	11
Front Panel Function Overview.....	12
Horizontal.....	12
Vertical	13
Trigger.....	14
Run Control	15
Universal Knob.....	16
Menu.....	17
Help.....	18
User Interface.....	19
To Use the Security Lock	21
To Set the Vertical System	22
To Enable the Channel	23
To Adjust the Vertical Scale	24
To Adjust the Vertical Position.....	24
To Specify Channel Coupling.....	25
To Specify Bandwidth Limit.....	25
To Specify Probe Attenuation Factor	26
To Specify channel Input Impedance	26
To Specify Amplitude Unit	27
To Invert a Waveform	27

Set the Horizontal System	28
Adjust the Horizontal Scale	29
Adjust Trigger Delay	30
Set the Roll mode	31
Use the Zoom Function	32
To Set the Sample System	33
Run Control	34
Overview of Sampling	35
Sampling Theory	35
Sample Rate	36
Oscilloscope Bandwidth and Sample Rate	37
Select Memory Depth	38
Select Sampling Mode	39
Select Waveform Interpolation Method	40
Select Acquisition Mode	42
Normal	42
Peak Detect	43
Average	44
High Resolution	45
Change the Horizontal Format	46
Use Sequence Mode	47
To Trigger the Oscilloscope	49
Trigger Source	51
Trigger Mode	52
Trigger Level	53
Trigger Coupling	54
Trigger Holdoff	55
Noise Rejection	56
Trigger Type	58
Edge Trigger	59
Slope Trigger	60
Pulse Trigger	62
Video Trigger	64
Window Trigger	67
Interval Trigger	70
DropOut Trigger	72
Runt Trigger	74
Pattern Trigger	76
Serial trigger and decode	78
IIC Trigger and Serial Decode	79
Setup for IIC Signals	79
IIC Triggering	80
IIC Serial Decode	83
SPI Triggering and Serial Decode	85

Setup for SPI Signals.....	85
SPI Triggering	88
SPI Serial Decode	90
UART/RS232 Triggering and Serial Decode.....	92
Setup for UART/RS232 Signals	92
UART/RS232 Triggering.....	93
UART/RS232 Serial Decode	94
To Save Reference Waveform.....	96
To Save REF Waveform to Internal Memory	97
To Display REF Waveform.....	97
To Adjust REF Waveform Display.....	98
To Clear REF Waveform Display.....	98
To Make Math Operation.....	99
Units for Math Waveforms	99
Math Operators	100
Addition or Subtraction.....	100
Multiplication and Division	101
FFT Operation.....	102
Math Function Operation.....	105
Differentiate	105
Integrate.....	106
Square Root.....	107
To Make Cursors Measurements	108
X Cursors	108
Y Cursors	108
To Make Cursor Measurements.....	109
To Make Measurements.....	110
Type of Measurement	111
Voltage Measurements	111
Time Measurements	113
Delay Measurements	114
To Make Automatic Measurement.....	115
To Clear Measurement Parameters.....	117
To Make All Measurement	117
Display Setting.....	118
To Set Display Type.....	119
To Set Color Display.....	120
To Set and Clear Persistence	120
To clear the display.....	121
To Select Grid Type	122
To Adjust Waveform Intensity	122
To Adjust Grid Brightness	124
To Adjust Transparence	124
Save and Recall.....	125

Save Type.....	126
Internal Save and Recall	127
External save and recall.....	128
Disk Management	131
To Create a New File or Folder	132
To delete a file or folder	133
To rename a file or a folder	133
System Function Setting.....	134
To View the System Status.....	135
To Do Self Calibration	136
To Enable or Disable the Sound	137
To Specify the Language	137
To Do Pass/Fail Test	138
To Set and Perform Pass/Fail Test	139
To Save and Recall Test Mask	140
IO Set.....	142
To Set the USB Device	142
To Set the LAN.....	143
To Set Aux Output.....	144
To Enable Quick-Cal.....	145
To Update Firmware and Configuration	146
Do Self Test.....	147
Screen Test.....	147
Keyboard Test	148
LED Test.....	149
To specify Screen Saver Time	150
Option Management.....	151
To Use the History Function.....	153
Arbitrary Waveform Generator	155
To Set Wave Type and Parameters	156
To Output Arbitrary Waveform.....	158
To Set Output Load.....	159
Recover the Default Values of Wave Gen.....	159
AWG Self Cal.....	160
Default Setup	161
Troubleshooting	167

Content of Figure

Figure 1 Front View.....	3
Figure 2 Top View	3
Figure 3 Adjust the Supporting Legs	4
Figure 4 To Connect to Power Supply	5

Figure 5 Function Inspection.....	8
Figure 6 Front Panel Overview	10
Figure 7 Rear panel Overview	11
Figure 8 Help Message.....	18
Figure 9 User Interface.....	19
Figure 10 To Use the Security Lock	21
Figure 11 Display Type Set to Dots.....	40
Figure 12 x Interpolation.....	41
Figure 13 Sinx Interpolation.....	41
Figure 14 Acquisition System	42
Figure 15 Pulse With 0.1% Duty, Normal Mode	43
Figure 16 Pulse With 0.1% Duty, Peak Detect Mode	43
Figure 17 With Random Noise, Normal Mode.....	44
Figure 18 With Random Noise, Average Mode.....	45
Figure 19 SEQUENCE Function Menu	47
Figure 20 HISTORY Function Menu	47
Figure 21 Turn off the Noise Reject.....	56
Figure 22 Turn on the Noise Reject.....	57
Figure 23 Edge Trigger.....	59
Figure 24 Slope Trigger.....	61
Figure 25 Pulse Trigger	63
Figure 26 Video Trigger	66
Figure 27 Absolute Window Trigger.....	68
Figure 28 Relative Window Trigger	69
Figure 29 Interval Trigger	71
Figure 30 Edge DropOut Trigger.....	73
Figure 31 State DropOut Trigger	73
Figure 32 Runt Trigger.....	75
Figure 33 Pattern Trigger.....	77
Figure 34 IIC SINGAL Menu	79
Figure 35 IIC TRIGGER Menu.....	80
Figure 36 IIC Decode Menu.....	83
Figure 37 IIC Decode Result	83
Figure 38 SPI SINGAL Menu	85
Figure 39 SPI Clock Menu.....	85
Figure 40 MOSI Menu	85
Figure 41 MOSI Menu	86
Figure 42 SPI CS Menu	86
Figure 43 SPI TRIG SET Menu	88
Figure 44 SPI Trigger.....	89
Figure 47 SPI Decode function menu.....	90
Figure 46 SPI Decode	90
Figure 47 UART SIGNAL Menu	92
Figure 48 BUS CONFIG Menu	92

Figure 49 UART TRIG SET Menu	93
Figure 50 UART Trigger.....	93
Figure 51 UART/RE232 DECODE Function Menu	94
Figure 52 UART Decode.....	94
Figure 53 Reference Waveform.....	98
Figure 54 FFT Waveform In Split Mode.....	104
Figure 55 Differential Function Operation	105
Figure 56 Integral without Offset.....	106
Figure 57 Integral with Offset	107
Figure 58 Square Root.....	107
Figure 59 Measure Pulse Width.....	109
Figure 60 Voltage Measurements	111
Figure 61 Overshoot.....	112
Figure 62 Preshoot	112
Figure 63 Time Measurements	113
Figure 64 Select the Measurement Parameter	115
Figure 65 Added the Measurement	116
Figure 66 All Parameters Measurement	117
Figure 67 Vectors Display.....	119
Figure 68 Dots Display.....	119
Figure 69 Color Temperature	120
Figure 70 Persist Set to Infinite	121
Figure 71 Intensity Set to 100%	123
Figure 72 Intensity Set to 10%	123
Figure 73 SAVE/RECALL File System.....	128
Figure 74 Select Save Location	129
Figure 75 File Name Dialogue	129
Figure 76 Input Keyboard.....	132
Figure 77 System Status	135
Figure 78 Do Self Cal	136
Figure 79 Pass/Fail Test	138
Figure 80 LAN Setting Interface	143
Figure 81 Screen Test	147
Figure 82 Keyboard Test.....	148
Figure 83 LED Test	149
Figure 84 Screen Saver Interface	150
Figure 85 OPTION Function Menu	151
Figure 86 LABEL Function Menu	151
Figure 87 Option Information	152
Figure 88 History	153
Figure 89 Send Wave Dialogue	158
Figure 90 Save Waveform Successfully	158
Figure 91 SETTING Function Menu	159
Figure 92 AWG Self Cal.....	160

Quick Start

This chapter introduces the preparations when using the oscilloscope for the first time, the front panel, rear panel and user interface of the oscilloscope,

The contents of this chapter:

- ◆ General Inspection
- ◆ Appearance and Dimensions
- ◆ To Prepare the Oscilloscope for Use
- ◆ Front Panel Overview
- ◆ Rear Panel Overview
- ◆ Front Panel Function Overview
- ◆ Back Panel Function Overview
- ◆ User Interface
- ◆ To Use the Security Lock

General Inspection

1. Inspect the shipping container for damage.

Keep the damaged shipping container or cushioning material until the contents of the shipment have been checked for completeness and the instrument has passed both electrical and mechanical tests.

The consigner or carrier shall be liable for the damage to instrument resulting from shipment. **SIGLENT** would not be responsible for free maintenance/rework or replacement of the unit.

2. Inspect the instrument.

In case of any damage, or defect, or failure, notify your **SIGLENT** sales representative.

3. Check the Accessories

Please check the accessories according to the packing lists. If the accessories are incomplete or damaged, please contact your **SIGLENT** sales representative.

Appearance and Dimensions

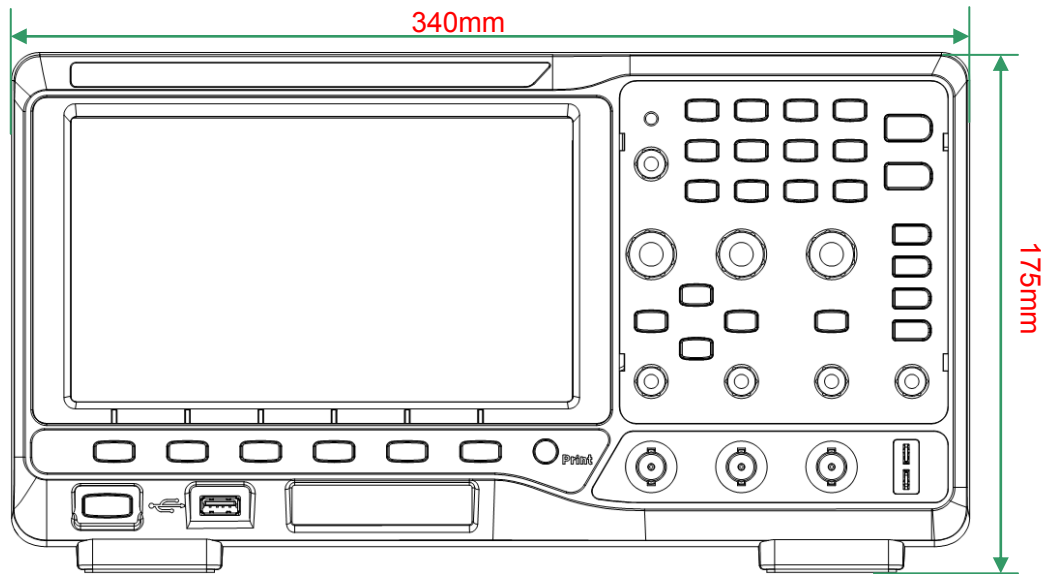

Figure 1 Front View

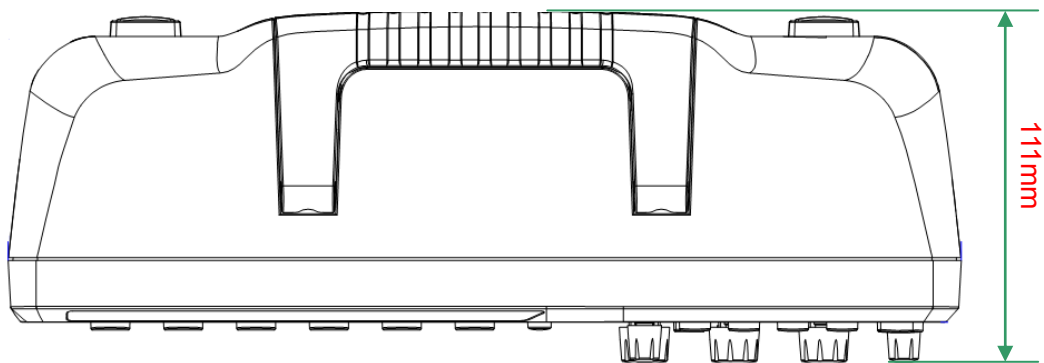

Figure 2 Top View

To Prepare the Oscilloscope for Use

To Adjust the Supporting Legs

Adjust the supporting legs properly to use them as stands to tilt the oscilloscope upwards for stable placement of the oscilloscope as well as better operation and observation.

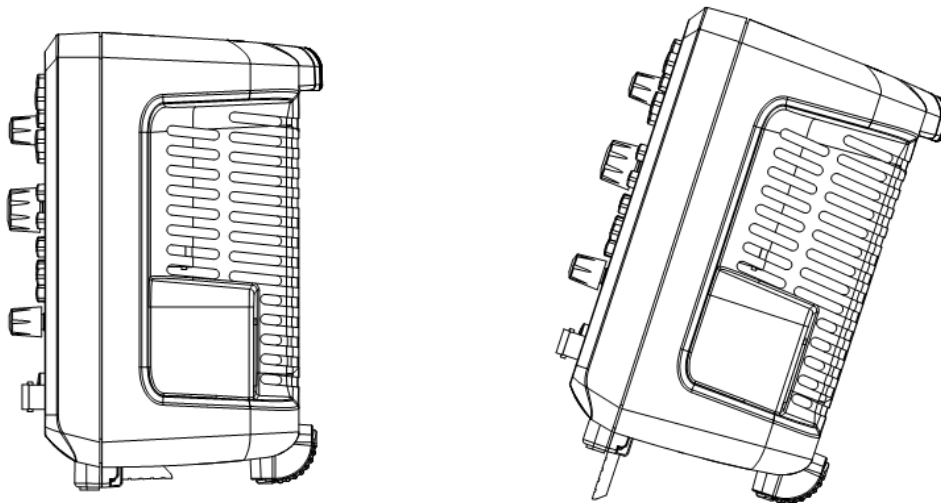

Figure 3 Adjust the Supporting Legs

To Connect to Power Supply

The power requirements of SDS1000X are 100-240 V, 50/60/440 Hz. Please use the power cord supplied with the accessories to connect the oscilloscope to the power source.

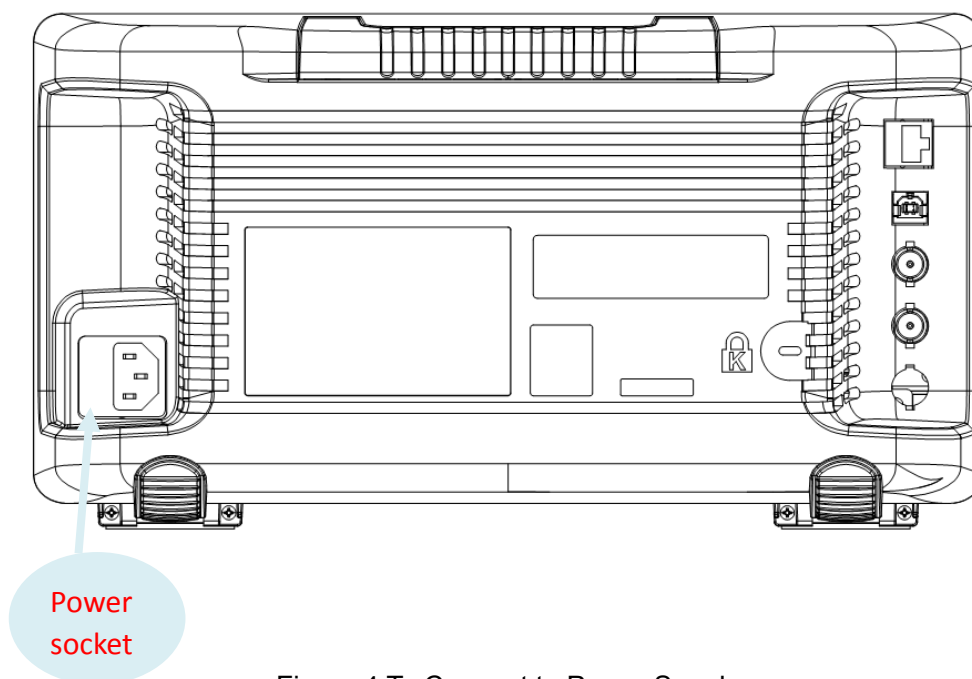

Figure 4 To Connect to Power Supply

Power-on Inspection

When the oscilloscope is energized, press the power key at the lower-left corner of the front panel to start the oscilloscope. During the start-up process, the oscilloscope performs a series of self-tests and you can hear the sound of relay switching. After the self-test is finished, the welcome screen is displayed.

To Connect the Probe

SIGLENT provides passive probes for the SDS1000X series oscilloscopes. For detailed technical information of the probes, please refer to the corresponding Probe User's Guide.

Connect the Probe:

1. Connect the BNC terminal of the probe to a channel BNC connector of the oscilloscope at the front panel.
2. Connect the probe tip to the circuit point to be tested and connect the ground alligator clip of the probe to the circuit ground terminal.

Function Inspection

1. Press the **Default** button on the front panel to restore the instrument to its default configuration.
2. Connect the ground alligator clip of the probe to the “Ground Terminal” under the probe compensation signal output terminal.

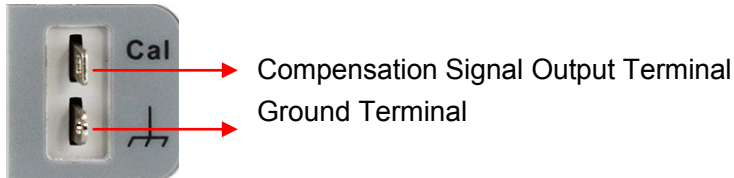

3. Use the probe to connect the input terminal of CH1 of the oscilloscope and the “Compensation Signal Output Terminal” of the probe.
4. Press the **Auto Setup** softkey.
5. Observe the waveform on the display. In normal condition, the display should be a square waveform as shown in the figure below:

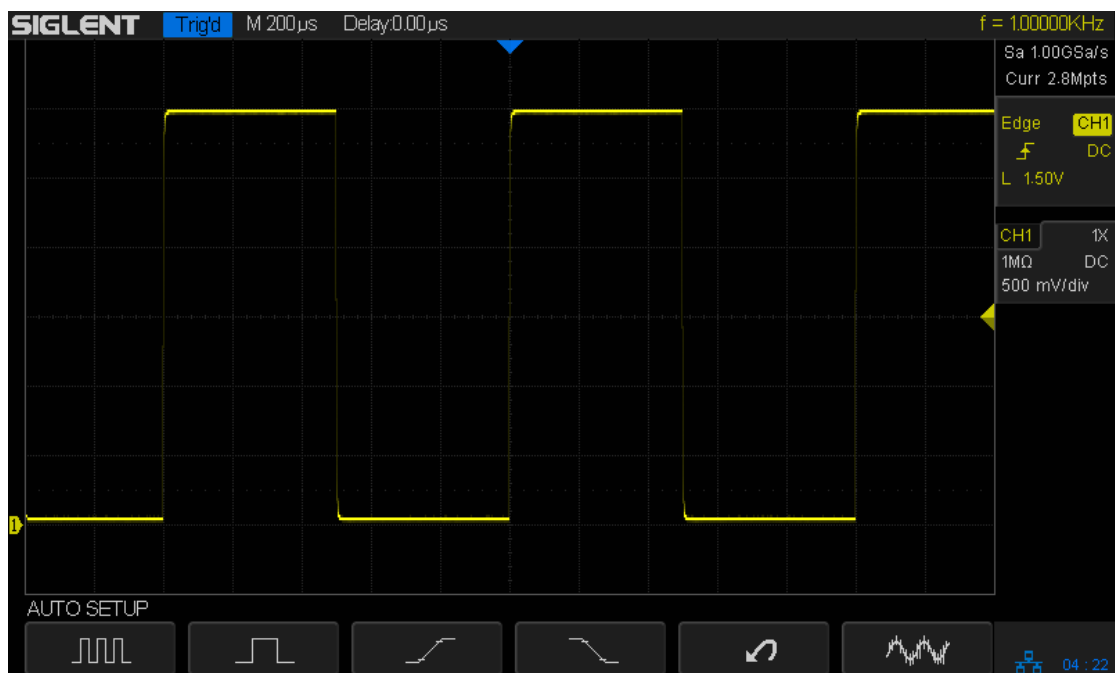

Figure 5 Function Inspection

6. Use the same method to test the other channels. If the square waveforms actually shown do not match that in the figure above, please perform “**Probe Compensation**” in the next section.



WARNING

To avoid electric shock during the use of probe, please make sure that the insulated wire of the probe is in good condition and do not touch the metallic part of the probe when the probe is connected to high voltage source

Probe Compensation

When the probes are used for the first time, you should compensate the probes to match the input channels of the oscilloscope. Non-compensated or poorly compensated probes may cause measurement inaccuracy or error. The probe compensation procedures are as follows.

1. Set the switch to 10X on the probe.
2. Perform steps 1, 2, 3 and 4 of **“Function Inspection”** in the previous section.
3. Check the waveforms displayed and compare them with the following:

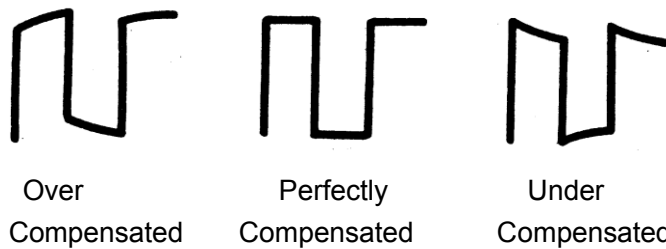

4. Use a nonmetallic driver to adjust the low-frequency compensation adjustment hole on the probe until the waveform displayed is as the “Perfectly compensated” in the figure above.

Front Panel Overview



Figure 6 Front Panel Overview

NO.	Description	NO.	Description
1	LCD Display	9	Trigger Control
2	Universal Knob	10	Vertical Control
3	Common Function Menus	11	Probe Comp
4	Wave Gen	12	Analog Channel Input
5	Decode Control	13	One-Button shortcut for Save
6	Run/Stop	14	Menu Softkey
7	Auto Setup	15	USB Host
8	Trigger Control	16	Power Button

Rear Panel Overview

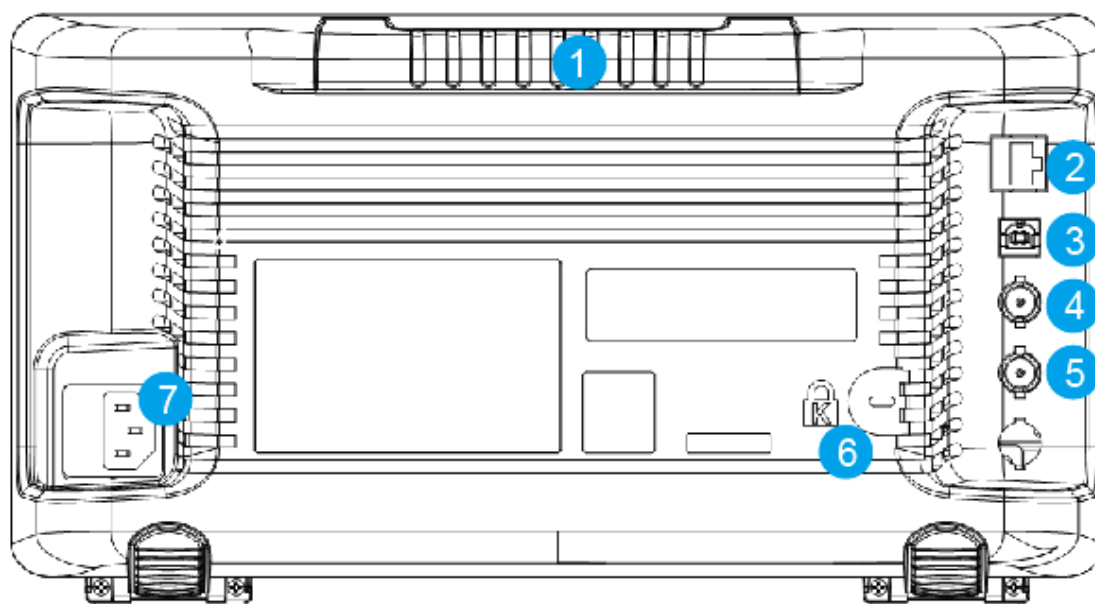

Figure 7 Rear panel Overview

- 1. Handle**
Pull up the handle vertically for easy carrying of the instrument. When you do not need the handle, press it down.
- 2. LAN**
The instrument can be connected to network via this interface to perform remote control.
- 3. USB Device**
SDS1000X series support SCPI remote control commands, user can control the oscilloscope through this interface.
- 4. Pass/Fail or Trigger Out**
The BNC port can output a signal that reflects the current waveform capture rate of the oscilloscope at each trigger or a pass/fail test pulse.
- 5. AWG Output terminal**
The model SDS1102X-S and SDS1202X-S provide built-in signal generator function. The max output frequency is 25MHz.
- 6. Safety lock Hole**
You can lock the instrument to a fixed location using the security lock (please buy it yourself) via the lock hole.
- 7. AC Power Socket**
AC power input terminal. The power requirements of this oscilloscope are 100-240 V, 50/60/440 Hz. Use the power cord provided with the accessories to connect the instrument to AC power. Then, you can press the power key at the front panel to start the instrument.

Front Panel Function Overview

Horizontal



: Quickly enter the roll mode. The timebase range is from 50mS/div to 50S/div.

Horizontal Position Knob



: adjust horizontal position. The trigger point would move left or right relative to the center of the screen when you turn the knob. During the modification, waveforms of all the channels would move left or right and the trigger position message at the upper-right corner of the screen would change accordingly. Press down this knob to quickly reset the trigger delay to Zero.

Horizontal Scale Knob



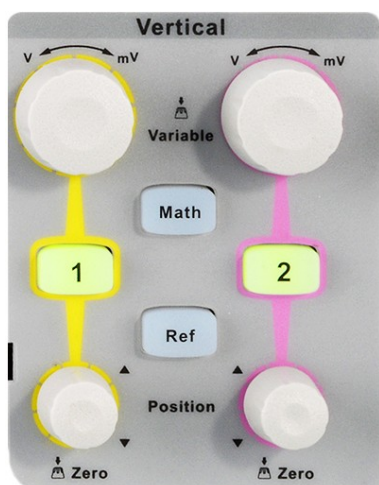

: adjust the horizontal time base. Turn clockwise to reduce the time base and turn counterclockwise to increase the time base. During the modification, waveforms of all the channels will be displayed in expanded or compressed mode and the time base message at the upper-left side of the screen would change accordingly. Press down this knob to quickly turn on Zoom function.

Vertical



 : Analog input channels. The two channels are marked by different colors which are also used to mark both the corresponding waveforms on the screen and the channel input connectors. Press any key to open the corresponding channel menu and press again to turn off the channel.

Vertical Position Knob  : adjust the vertical position of the current channel waveform. Turn clockwise to increase the position and turn counterclockwise to decrease. During the modification, the waveform would move up and down and the position message at the lower-left corner of the screen would change accordingly. Press down this knob to quickly reset the vertical position to zero.

Vertical Variable Knob  : adjust the vertical scale of the current channel. Turn clockwise to decrease the scale and turn counterclockwise to increase. During the modification, the amplitude of the waveform would enlarge or reduce and the scale information at the right side of the screen would change accordingly. Press down this knob to quickly switch the vertical scale adjustment modes between “Coarse” and “Fine”.

Math : press the button to enter the MATH function menu. SDS1000X provides addition, subtraction, multiplication, FFT, differential, integral and square root operations.

Ref : press the button to enter the REF function menu. A reference waveform can be displayed and compared against other waveforms.

Trigger

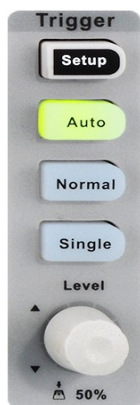

 : press the button to enter the TRIGGER function menu. SDS1000X provides abundant advanced trigger functions

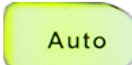
 : press the button to set the trigger mode to Auto.

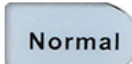
 : press the button to set the trigger mode to Normal.

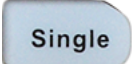
 : press the button to set the trigger mode to Single.

Trigger Level Knob



: adjust the trigger level. Turn clockwise to increase the level and turn counterclockwise to reduce the level. During the modification, the trigger level line would move up and down and the value in the trigger level message box at the up-right corner of the screen would change accordingly. Press down the knob to quickly reset the trigger level to center of the waveform.

Run Control



Auto Setup : press this key to enable the waveform auto setting function. The oscilloscope will automatically adjust the vertical scale, horizontal time base and trigger mode according to the input signal to realize optimum waveform display.

Run/Stop : press the button to set the acquisition state to Run or Stop. In RUN state, the key is illuminated in yellow. In STOP state, the key is illuminated in red.

Decode : press the button to enter the DECODE function menu. SDS1000X supports IIC, SPI, UART/RS232, CAN and LIN serial bus decode.

Wave Gen : press the button to enable the Wave Gen function and open the waveform function menu.

Universal Knob



1. Adjust the waveform intensity.

When there is no menu operation, turn the knob to adjust the intensity of the displayed waveforms. The adjustable range is from 0% to 100%. Turn clockwise to increase the intensity and counterclockwise to reduce. You can also press the **Display/Persist** button; press the **Next Page** softkey to go to the second page of the DISPLAY function menu; press the **Intensity** softkey and then turn the **Universal Knob** to adjust the waveform intensity.

2. Select the desired submenu.

In menu operation, press any menu softkey and turn the **Universal Knob** to select the desired submenu under the menu and push down the knob to confirm the current submenu. Turn clockwise to up the intensity and counterclockwise to down.

3. Modify parameters.

After having chosen a parameter, turn the **Universal Knob** to modify the value. Turn clockwise to increase the intensity and counterclockwise to reduce. In addition, it can also be used to adjust scale and offset of MATH and REF.

4. Choose file or directory or input filename.

After having entered the file system, turn the **Universal Knob** to select the desired file or directory. When inputting filename, turn the **Universal Knob** to select the desired character and the push the knob to confirm.

Menu

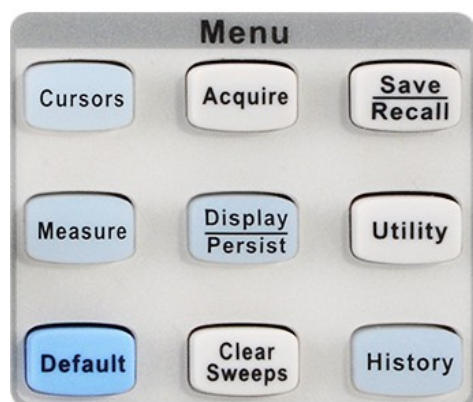

- Cursors** : Press the button to enter the CURSOR function menu. SDS1000X provides manual and track cursor mode.

- Display Persist** : Press the button to enter the DISPLAY function menu and quickly enable the persist function. User can set the grid, intensity, brightness, transparance.

- Utility** : Press the button to enter the UTILITY function menu to look at the system status, do self calibration, set the sound, language and so on.

- Clear Sweeps** : The button is a shortcut key for clear function. When the measurement statistics is ON, press the button to clear the count and recount it. When persist is enabled, press the button to clear persist.

- History** : Press the button to enter the history mode. In history mode, it can record most 80000 frames waveforms. If sequence function is enabled, it only record the frames which you set, the most you can set is 1024.

- Measure** : Press the button to enter the MEASURE function menu to set the measurement parameters, all measurement, statistics and set the gate.

- Acquire** : Press the button to enter the ACQUIRE function menu to set the acquisition mode, memory depth, wave interpolation and so on.

- Save Recall** : Press the button to enter the SAVE/RECALL function menu to save setups, waveforms, pictures, or CSV files to internal memory or USB flash driver.

- Default** : Press the button to reset the oscilloscope to its default setup. The default voltage scale and time scale are respectively 1V/div and 1uS/div.

Help

SDS1000X has an on line help function that supplies multi-language help information, and you can recall then to help you operate the oscilloscope when you need.

Press the any buttons for 2 seconds to enter the on line help. All submenus of every main menu have their help information.

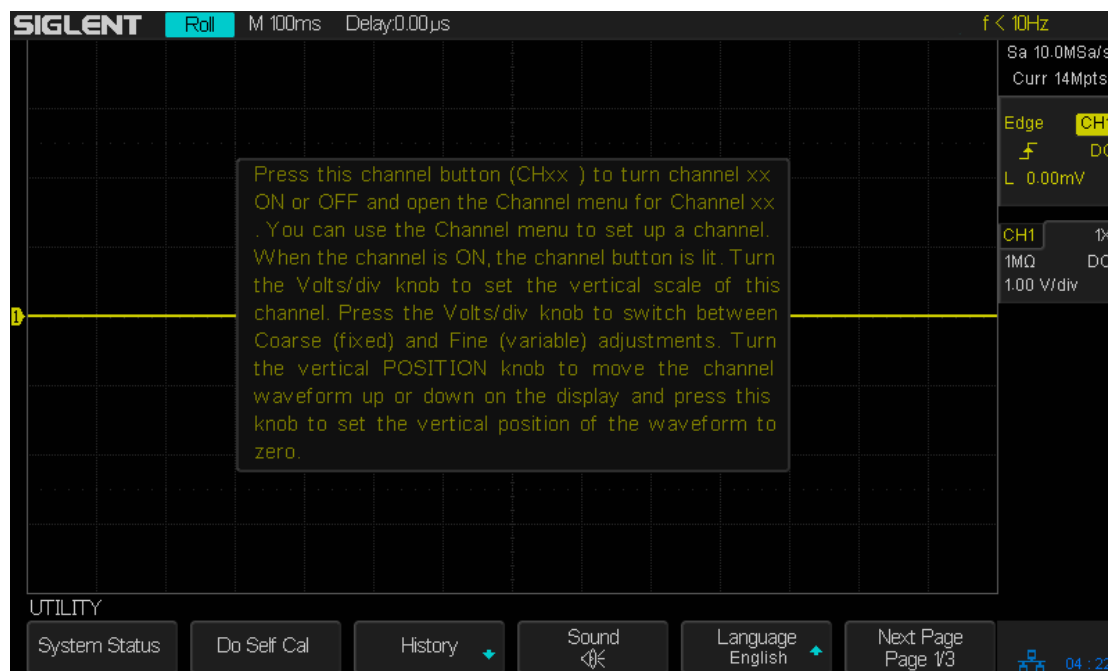

Figure 8 Help Message

User Interface

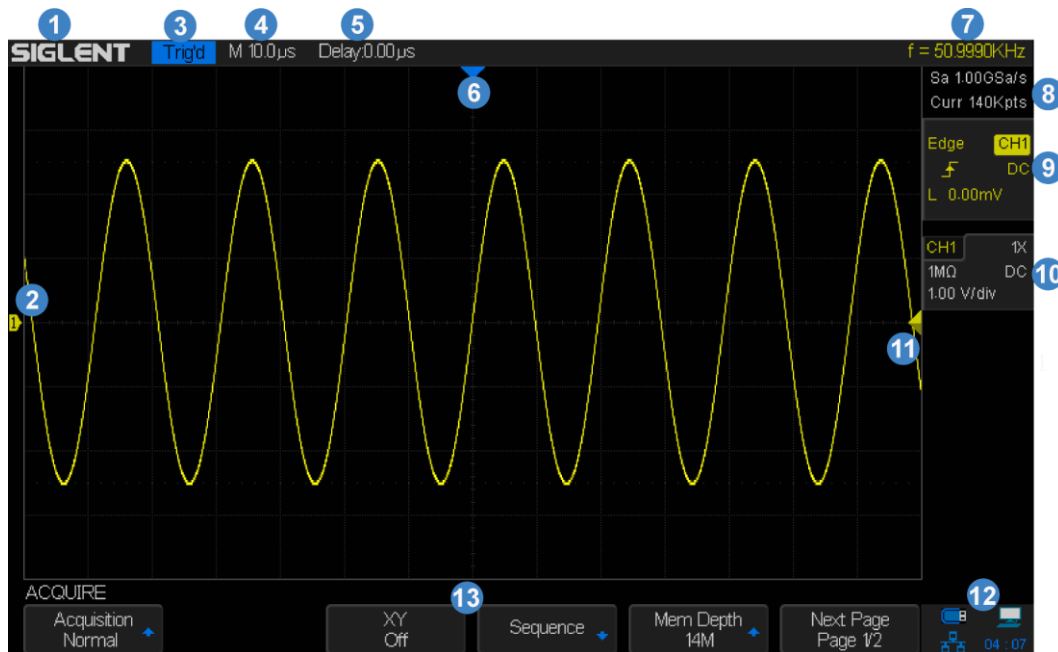

Figure 9 User Interface

1. **Product Logo**
SIGLENT is the registered trademark of **SIGLENT TECHNOLOGIES CO., LTD.**
2. **Channel Label/Waveform**
 Different channels are marked by different colors and the color of the waveform complies with the color of the channel.
3. **Trigger Status**
 Available trigger status includes Ready, Auto, Stop, Arm, Trig'd.
4. **Horizontal Time Base**
 - Represent the time per grid on the horizontal axis on the screen.
 - Use the **HORIZONTAL SCALE Knob** to adjust the parameter. The available range is from 2.0 ns to 50 s.
5. **Trigger Position**
 Turn the Horizontal Position Knob to adjust the parameter. Push the knob to set the value to 0 automatically.
6. **Trigger Delay Label**
 Indicate the trigger delay on the waveform.

7. Frequency Counter

Display the frequency value of the trigger channel.

8. Sampling Rate/ Memory Depth

Display the current sampling rate and memory depth. Sa means the current sampling rate and Curr means the current memory depth. Turn the **Universal Knob** to adjust the parameter

9. Trigger Setup

Trigger Type  : display the current trigger type. The trigger type names display by the abbreviation when the name is too long to display.

Trigger source  : display the currently trigger source. Different channels display in different color.

Trigger condition  : display the current trigger condition.

Trigger coupling  : display the current trigger coupling. Available trigger coupling mode: DC, AC, HF Reject, LF Reject.

Trigger level  : display the current value of trigger level. Push the knob to set the trigger to the 50% of the waveform amplitude automatically.

10. Channel Setup

Probe attenuation factor  : display the current probe attenuation factor of the channel. Available probe attenuation factors: 0.1X, 0.2X, 0.5X, 1X, ...2000X, 5000X, 10000X.

Input impedance  : display the current input impedance of the channel. Input impedance that available: 1MΩ or 50Ω.

Channel coupling  : display the current channel coupling of the channel. Channel coupling that available: DC, AC, and GND.

Vertical Scale  : display the current vertical scale of the channel. Turn the Vertical Scale Knob to adjust the value.



11. Trigger Level Label

Display the position of trigger level, the color is the same to the trigger channel. It can move from +4.5div to -4.5div of the screen center.

12. I/O status

 Indicate that the **USB Device** (USBTMC) is connected.

 Indicate that the USB Host is connected.

 Indicate that the LAN port is connected,  Indicate it is disconnected.

13. Menu

Display the corresponding function menu of the selected button. Press the corresponding softkey to set the oscilloscope.

To Use the Security Lock

If needed, you can use the security lock (please buy it yourself) to lock the oscilloscope to a fixed location. The method is as follows, align the lock with the lock hole and plug it into the lock hole vertically, turn the key clockwise to lock the oscilloscope and then pull the key out.

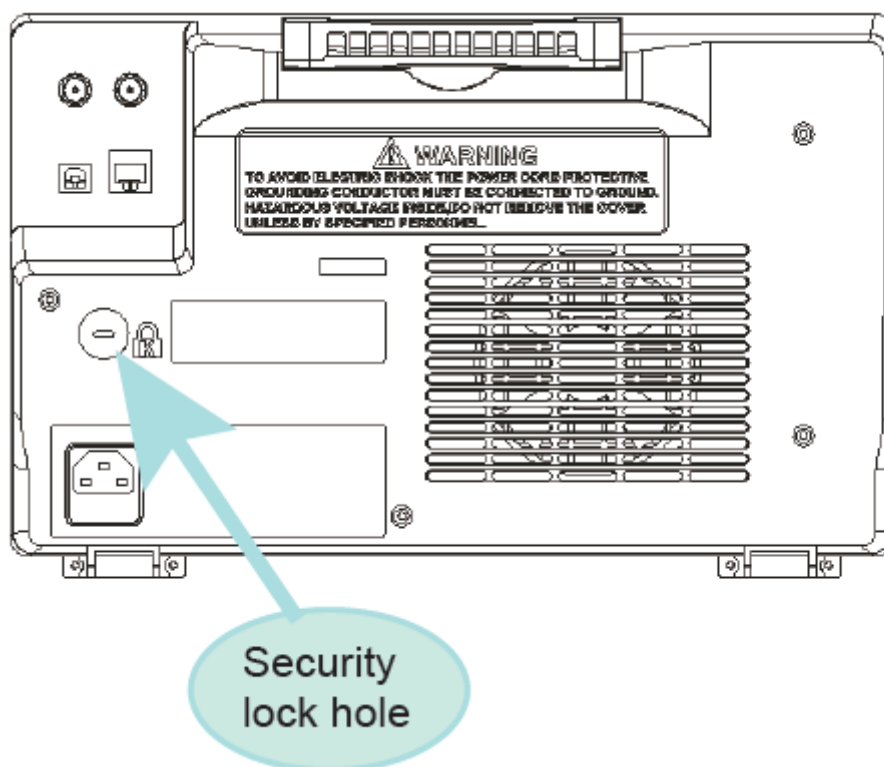

Figure 10 To Use the Security Lock

To Set the Vertical System

This chapter introduces how to set the vertical system of the oscilloscope.

The contents of this chapter:

- ◆ To Enable the Channel
- ◆ To Adjust the Vertical Scale
- ◆ To Adjust the Vertical Position
- ◆ To Specify Channel Coupling
- ◆ To Specify Bandwidth Limit
- ◆ To Specify Probe Attenuation Factor
- ◆ To Specify channel Input Impedance
- ◆ To Specify Amplitude Unit
- ◆ To Invert a Waveform

To Enable the Channel

SDS1000X provides 2 analog input channels (CH1, CH2) and provides independent vertical control system for each channel. As the vertical system setting methods of both channels are the same, this chapter takes CH1 as an example to introduce the setting method of the vertical system.

Connect a signal to the CH1 channel connector; and then press the **CH1** button in the vertical control area (VERTICAL) at the front panel to enable CH1.

The channel setting menu is displayed at the bottom of the screen and the channel label at the right side of the screen. The information displayed in the channel label is related to the current channel setting.

After the channel is turned on, modify the parameters such as the vertical scale, the horizontal time base and the trigger mode according to the input signal to make the waveform display easy to observe and measure.

Note: to turn off the channel, press the channel button twice.

To Adjust the Vertical Scale

The vertical scale can be adjusted in **Coarse** or **Fine** mode.

- **Coarse** adjustment (take counterclockwise as an example): set the vertical scale in 1-2-5 step namely 500uV/div, 1 mV/div, 2 mV/div, 5 mV/div, 10 mV/div ... 10 V/div.
- **Fine** adjustment: further adjust the vertical scale within a relatively smaller range to improve vertical resolution. For example: 2 V/div, 1.98V/div, 1.96V/div, 1.94 V/div ... 1 V/div.

If the amplitude of the input waveform is a little bit greater than the full scale under the current scale and the amplitude would be a little bit lower if the next scale is used, fine adjustment can be used to improve the amplitude of waveform display to view signal details.

Press the **CH1** button on the front panel; then press the **Adjust** softkey to select the desired mode. Turn the **VERTICAL Variable Knob** to adjust the vertical scale (clockwise to reduce the scale and counterclockwise to increase).

The scale information in the channel label at the right side of the screen will change accordingly during the adjustment. The adjustable range of the vertical scale is related to the probe ratio currently set. By default, the probe attenuation factor is 1X and the adjustable range of the vertical scale is from 500uV/div to 10 V/div.

Note: push the **VERTICAL Variable Knob** to quickly switch between **Coarse** and **Fine** adjustments.

To Adjust the Vertical Position

Turn the **VERTICAL Position Knob** to adjust the vertical position of the channel waveform. Turn the knob clockwise to increase the vertical position and the channel waveform moves up while counterclockwise to reduce the vertical position and the waveform moves down. Push the knob to set the vertical position of the channel waveform to zero.

During the adjustment, the vertical position information Volts Pos displays at the bottom of the screen. The table below shows the range of vertical position according to the volt scale.

Volt Scale	Range of Vertical Position
500 μ V/div ~ 100 mV/div	± 1 V
102 mV/div ~ 1 V/div	± 10 V
1.02 V/div ~ 10 V/div	± 100 V

To Specify Channel Coupling

Set the coupling mode to filter out the undesired signals. For example, the signal under test is a square waveform with DC offset.

- When the coupling mode set to **DC**: the DC and AC components of the signal under test can both pass the channel.
- When the coupling mode set to **AC**: the DC components of the signal under test are blocked.
- When the coupling mode set to **GND**: the DC and AC components of the signal under test are both blocked.

Press the **CH1** button on the front panel; then press the **Coupling** softkey and turn the **Universal Knob** to select the desired coupling mode. The default setup is **DC**.

The current coupling mode is displayed in the channel label at the right side of the screen. You can also press the **Coupling** softkey continuously to switch the coupling mode.

To Specify Bandwidth Limit

Set the bandwidth limit to reduce display noise. For example, the signal under test is a pulse with high frequency oscillation.

- When the bandwidth limit set to **Full**, the high frequency components of the signal under test can pass the channel.
- When the bandwidth limit set to **20M**, the high frequency components that exceed 20 MHz are attenuated.

Press the **CH1** button on the front panel; then press the **BW Limit** softkey to select **Full** or **20M**. The default setup is **Full**. When bandwidth limit is enabled, the character **B** will be displayed in the channel label at the right side of the screen.

At 2 mV/div volt scale, the **BW Limit** is set to **20M** automatically, and cannot be turned off.

To Specify Probe Attenuation Factor

Set the probe attenuation factor to match the type of the probe that you are using to ensure correct vertical readouts.

Press the **CH1** button on the front panel; then press the **Probe** softkey and turn the **Universal Knob** to select the desired value and push the knob to confirm. The default setup is **1X**.

The current probe attenuation factor is displayed in the channel label at the right side of the screen. You can also press the **Probe** softkey continuously to switch the probe attenuation factor.

The table shows the probe attenuation factor

Menu	Attenuation Factor
0.1X	0.1 : 1
0.2X	0.2 : 1
0.5X	0.5 : 1
1X	1 : 1
2X	2 : 1
...	...
5000X	5000 : 1
10000X	10000 : 1

To Specify channel Input Impedance

The channel input impedance matching gives you the most accurate measurements because reflections are minimized along the signal path.

- Impedance setting to $1M\Omega$ is for use with many passive probes and for general-purpose measurements. The higher impedance minimizes the loading effect of the oscilloscope on the device under test.
- Impedance setting to 50Ω matches 50 ohm cables commonly used in making high frequency measurements, and 50 ohm active probes.

Press the CH1 button on the front panel; then press the **Impedance** softkey to select the desired impedance.

The current channel input impedance is displayed in the channel label at the right side of the screen.

To Specify Amplitude Unit

Select the amplitude display unit for the current channel. The available units are **V** and **A**. When the unit is changed, the unit displayed in the channel label will change accordingly.

1. Press **CH1** button on the front panel to enter the CH1 function menu.
2. Press the **Next Page** softkey to enter the second page of the CH1 function menu.
3. Press the **Unit** softkey to select the desired unit **V** or **A**. □

The default setup is **V**.

To Invert a Waveform

When **Invert** is set to **On**, the voltage values of the displayed waveform are inverted. Invert affects how a channel is displayed and it keeps the trigger settings.

Inverting a channel also changes the result of any math function selected and measure function.

1. Press **CH1** button on the front panel to enter the CH1 function menu.
2. Press the **Next Page** softkey to enter the second page of the CH1 function menu.
3. Press the **Invert** softkey to turn on or off the invert display.

Set the Horizontal System

This chapter introduces how to set the horizontal system of the oscilloscope.

The contents of this chapter:

- ◆ Adjust the Horizontal Scale
- ◆ Adjust the Trigger Delay
- ◆ Set Roll Mode
- ◆ Use the Zoom Function

Adjust the Horizontal Scale

Turn the **HORIZONTAL Scale Knob** on the front panel to adjust the horizontal time base. Turn clockwise to reduce the horizontal time base and turn counterclockwise to increase.

The time base information at the upper left corner of the screen will change accordingly during the adjustment. The range of the horizontal scale is from 2ns/div to 50s/div.

The Horizontal Scale Knob works (in the Normal time mode) while acquisitions are running or when they are stopped. When running, adjusting the horizontal scale knob changes the sample rate. When stopped, adjusting the horizontal scale knob lets you zoom into acquired data.

Adjust Trigger Delay

Turn the Position Knob on the front panel to adjust the trigger delay of the waveform. During the modification, waveforms of all the channels would move left or right and the trigger delay message at the upper-right corner of the screen would change accordingly. Press down this knob to quickly reset the trigger delay.

Changing the delay time moves the trigger point (solid inverted triangle) horizontally and indicates how far it is from the time reference point. These reference points are indicated along the top of the display grid.

All events displayed left of the trigger point happened before the trigger occurred. These events are called pre- trigger information, and they show events that led up to the trigger point.

Everything to the right of the trigger point is called post- trigger information. The amount of delay range (pre- trigger and post- trigger information) available depends on the time/div selected and memory depth.

The position knob works (in the Normal time mode) while acquisitions are running or when they are stopped. When running, adjusting the horizontal scale knob changes the sample rate. When stopped, adjusting the horizontal scale knob lets you zoom into acquired data.

Set the Roll mode

Press the **Roll** button to enter the roll mode.

In Roll mode the waveform moves slowly across the screen from right to left. It only operates on time base settings of 50 ms/div and slower. If the current time base setting is faster than the 50 ms/div limit, it will be set to 50 ms/div when Roll mode is entered.

In Roll mode there is no trigger. The fixed reference point on the screen is the right edge of the screen and refers to the current moment in time. Events that have occurred are scrolled to the left of the reference point. Since there is no trigger, no pre-trigger information is available.

If you would like to stop the display in Roll mode, press the **Run/Stop** button. To clear the display and restart an acquisition in Roll mode, press the **Run/Stop** button again.

Use Roll mode on low-frequency waveforms to yield a display much like a strip chart recorder. It allows the waveform to roll across the display.

Use the Zoom Function

Zoom is a horizontally expanded version of the normal display. You can use Zoom to locate and horizontally expand part of the normal window for a more detailed (higher-resolution) analysis of signals.

Press the **HORIZONTAL Scale Knob** on the front panel to turn on the zoom function, and press the button again to turn off the function. When Zoom function is on, the display divides in half. The top half of the display shows the normal time base window and the bottom half displays a faster Zoom time base window.

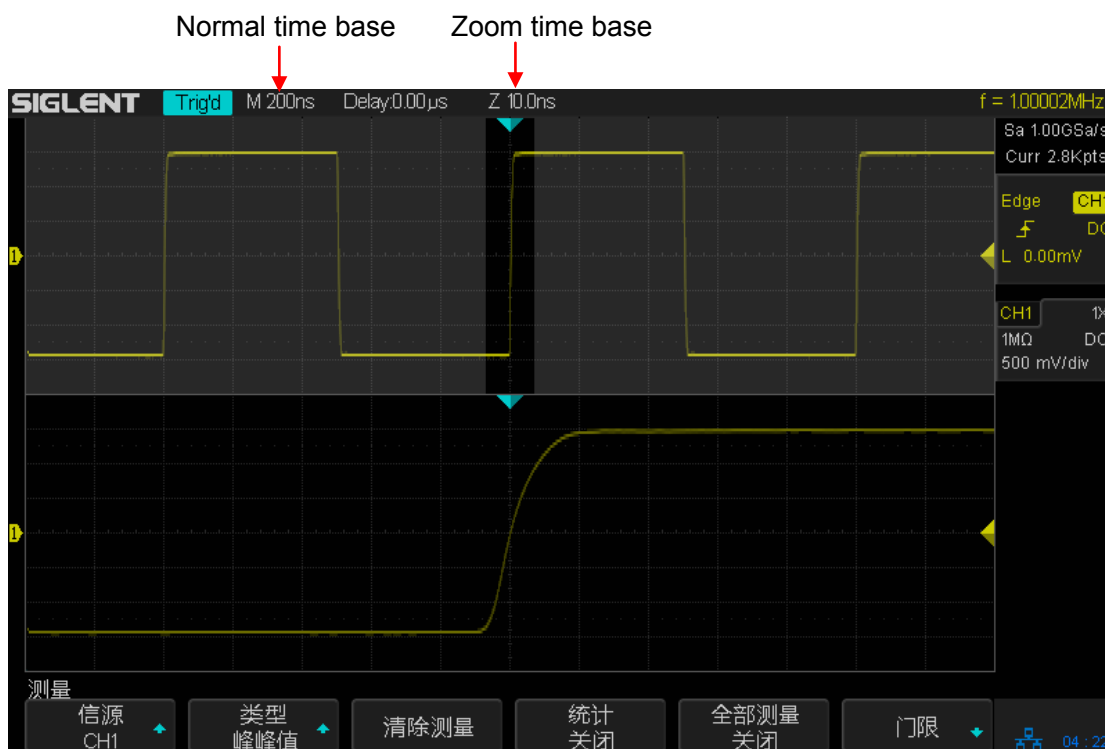

The area of the normal display that is expanded is outlined with a box and the rest of the normal display is ghosted. The box shows the portion of the normal sweep that is expanded in the lower half.

To change the time base for the Zoom window, turn the **Horizontal Scale Knob**. The **Horizontal Scale Knob** controls the size of the box. The **Horizontal Position Knob** sets the left-to-right position of the zoom window. The delay value, which is the time displayed relative to the trigger point is momentarily displayed in the upper-right corner of the display when the **Horizontal Position Knob** is turned. Negative delay values indicate you're looking at a portion of the waveform before the trigger event, and positive values indicate you're looking at the waveform after the trigger event.

To change the time base of the normal window, turn off Zoom; then, turn the **Horizontal Scale Knob**.

To Set the Sample System

This chapter introduces how to use the run control and set the sampling system of the oscilloscope.

The contents of this chapter:

- ◆ Run Control
- ◆ Overview of Sampling
- ◆ To Specify Memory Depth
- ◆ To Select Sampling Mode
- ◆ Waveform Interpolation Method

Run Control

Press the **Run/Stop** or **Single** button on the front panel to run or stop the sampling system of the scope.

- When the **Run/Stop** b is green, the oscilloscope is running, that is, acquiring data when trigger conditions are met. To stop acquiring data, press the **Run/Stop** button. When stopped, the last acquired waveform is displayed.
- When the **Run/Stop** button is red, data acquisition is stopped. Red "Stop" is displayed next to the trademark logo in the status line at the top of the display. To start acquiring data, press **Run/Stop**.
- To capture and display a single acquisition (whether the oscilloscope is running or stopped), press **Single**. The **Single** run control lets you view single- shot events without subsequent waveform data overwriting the display. Use **Single** when you want maximum memory depth for pan and zoom.

When you press **Single**, the display is cleared, the trigger mode is temporarily set to Normal (to keep the oscilloscope from auto- triggering immediately), the trigger circuitry is armed, the **Single** key is illuminated, and the oscilloscope waits until a user defined trigger condition occurs before it displays a waveform.

When the oscilloscope triggers, the single acquisition is displayed and the oscilloscope is stopped (the **Run/Stop** button is illuminated in red).

Press **Single** again to acquire another waveform

Overview of Sampling

To understand the oscilloscope's sampling and acquisition modes, it is helpful to understand sampling theory, sample rate and oscilloscope bandwidth and sample rate.

Sampling Theory

The Nyquist sampling theorem states that for a limited bandwidth (band-limited) signal with maximum frequency f_{MAX} , the equally spaced sampling frequency f_S must be greater than twice the maximum frequency f_{MAX} , in order to have the signal be uniquely reconstructed without aliasing.

$f_{MAX} = f_{S/2} = \text{Nyquist frequency } (f_N) = \text{folding frequency}$

Sample Rate

The maximum sample rate of SDS1000X is 1GSa/s. The actual sample rate of the oscilloscope is determined by the horizontal scale. Turn the **Horizontal Scale Knob** to adjust the sample rate.

The actual sample rate is displayed in the information area at the upper-right corner of the screen.

The influence on the waveform when the sample rate is too low:

1. **Waveform Distortion:** when the sample rate is too low, some waveform details are lost and the waveform displayed is rather different from the actual signal.

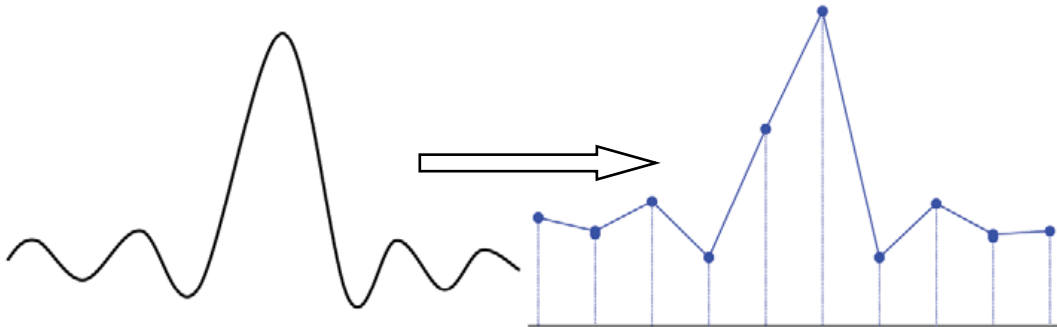

2. **Waveform Confusion:** when the sample rate is lower than twice the actual signal frequency (Nyquist Frequency), the frequency of the waveform rebuilt from the sample data is lower than the actual signal frequency. The most common aliasing is the jitter on fast edge.

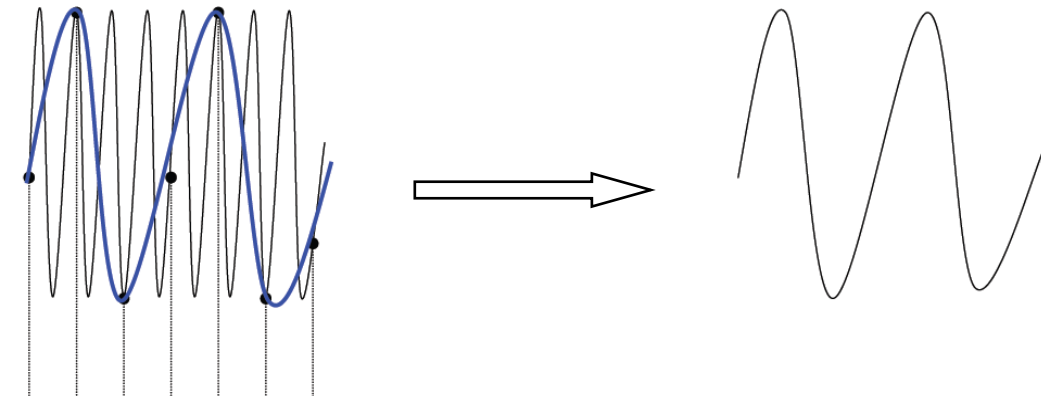

3. **Waveform Leakage:** when the sample rate is too low, the waveform rebuilt from the sample data does not reflect all the actual signal information.

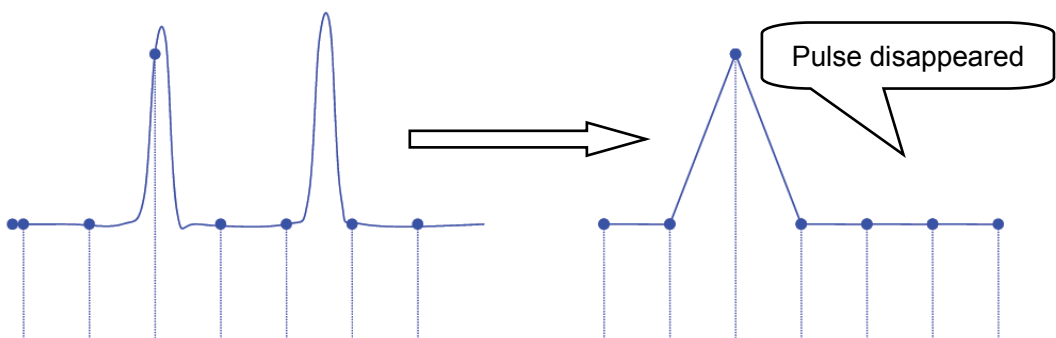

Oscilloscope Bandwidth and Sample Rate

An oscilloscope's bandwidth is typically described as the lowest frequency at which input signal sine waves are attenuated by 3 dB (-30% amplitude error).

At the oscilloscope bandwidth, sampling theory says the required sample rate is $f_s = 2f_{BW}$. However, the theory assumes there are no frequency components above f_{MAX} (f_{BW} in this case) and it requires a system with an ideal brick-wall frequency response.

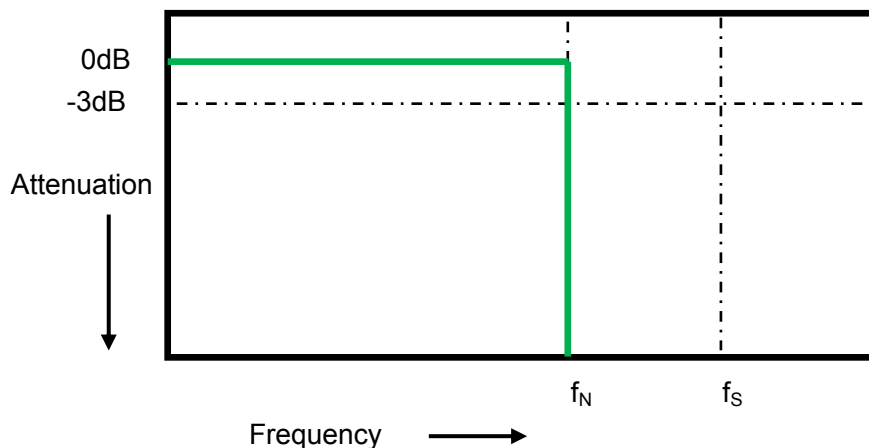

However, digital signals have frequency components above the fundamental frequency (square waves are made up of sine waves at the fundamental frequency and an infinite number of odd harmonics), and typically, for 500 MHz bandwidths and below, oscilloscopes have a Gaussian frequency response.

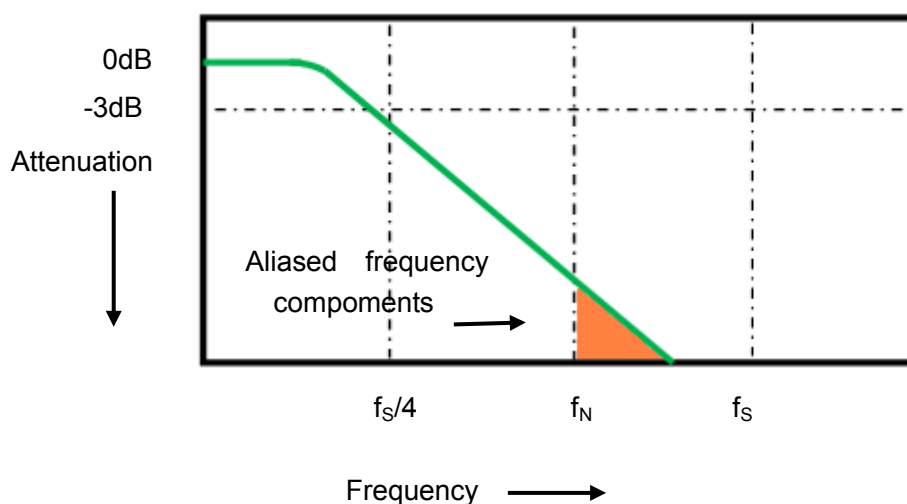

Limiting oscilloscope bandwidth (f_{BW}) to 1/4 the sample rate ($f_s/4$) reduces frequency components above the Nyquist frequency (f_N).

So, in practice, an oscilloscope's sample rate should be four or more times its bandwidth: $f_s = 4f_{BW}$. This way, there is less aliasing, and aliased frequency components have a greater amount of attenuation.

Select Memory Depth

Memory depth refers to the number of waveform points that the oscilloscope can store in a single trigger sample and it reflects the storage ability of the sample memory. SDS1000X provides up to 14 Mpts memory depth.

Press the **Acquire** button on the front panel; press the **Mem Depth** softkey and then turn the **Universal Knob** to select the desired value and push down the knob to confirm. Press the **Mem Depth** softkey continually can also select the desired value.

The actual memory depth is displayed in the information area at the upper- right corner of the screen. Memory depth that available: 14K, 140K, 1.4M, 14M.

Since the oscilloscope has two acquisition memories, when only one channel is on, the maximal memory depth is up to 14 Mpts.

The relation of memory depth, sample rate and waveform length fulfills the equation below:

Memory depth = sample rate (Sa/s) × waveform length (s/div × div)

Select Sampling Mode

SDS1000X only supports real-time sample. In this mode, the oscilloscope samples and displays waveform within a trigger event. The maximum real-time sample rate of SDS1000X is 1GSa/s.

Press the **RUN/STOP** button to stop the sample, the oscilloscope will hold the last display. At this point, you can still use the vertical control and horizontal control to pan and zoom the waveform.

Select Waveform Interpolation Method

Under real-time sampling, the oscilloscope acquires the discrete sample values of the waveform being displayed. In general, a waveform of dots display type is very difficult to observe. In order to increase the visibility of the signal, the digital oscilloscope usually uses the interpolation method to display a waveform.

Interpolation method is a processing method to “connect all the sampling points”, and using some points to calculate the whole appearance of the waveform. For real-time sampling interpolation method is used, even if the oscilloscope in a single captures only a small number of sampling points. The oscilloscope can use interpolation method for filling out the gaps between points, to reconstruct an accurate waveform.

Press the **Acquire** button on the front panel to enter the ACQUIRE Function menu; then press the **Sinx/X** softkey to select **Sinx** or **X**.

- **X**: In the adjacent sample points are directly connected on a straight line. This method is only confined to rebuild on the edge of signals, such as square wave.
- **Sinx**: Connecting the sampling points with curves has stronger versatility. Sinx interpolation method uses mathematical processing to calculation results in the actual sample interval. This method bending signal waveform, and make it produce more realistic regular shape than pure square wave and pulse. When the sampling rate is 3 to 5 times the bandwidth of the system. Recommended sinx interpolation method.



Figure 11 Display Type Set to Dots

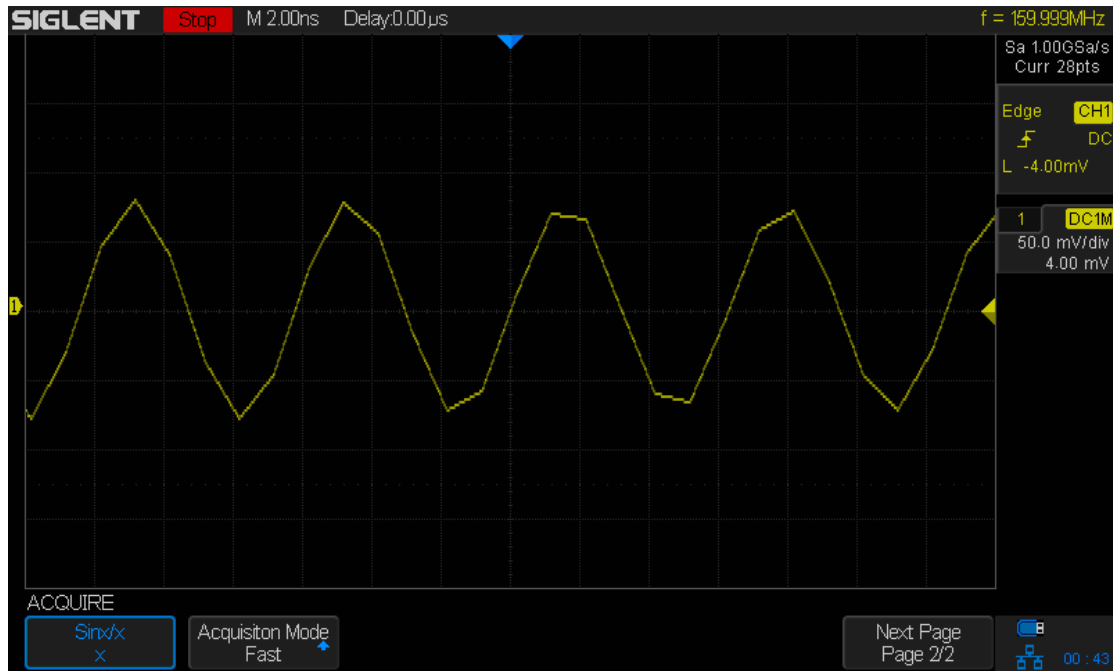

Figure 12 x Interpolation

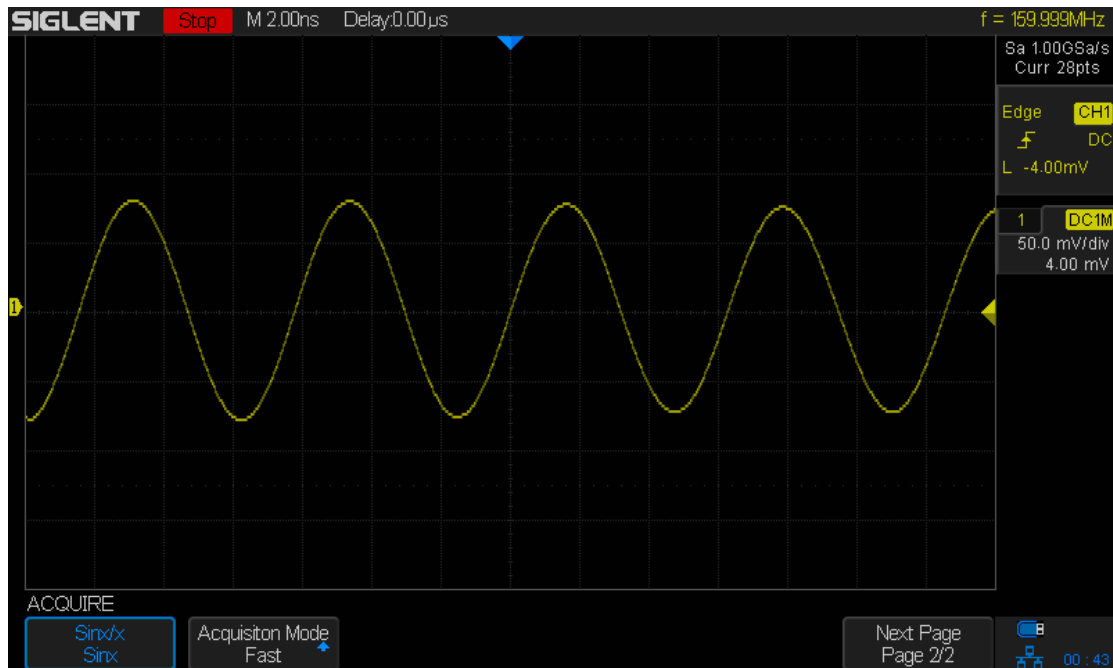

Figure 13 Sinx Interpolation

Select Acquisition Mode

The acquisition mode is used to control how to generate waveform points from sample points. SDS1000X provides the following acquisition mode: Normal, Peak Detect, Average and High Resolution.

1. Press the **Acquire** button on the front panel to enter the ACQUIRE function menu;
2. Press the **Acquisition** softkey; then turn the **Universal Knob** to select the desired acquisition mode and push down the knob to confirm. The default setup is **Normal**.

Normal

In this mode, the oscilloscope samples the signal at equal time interval to rebuild the waveform. For most of the waveforms, the best display effect can be obtained using this mode. It is the default acquisition mode.

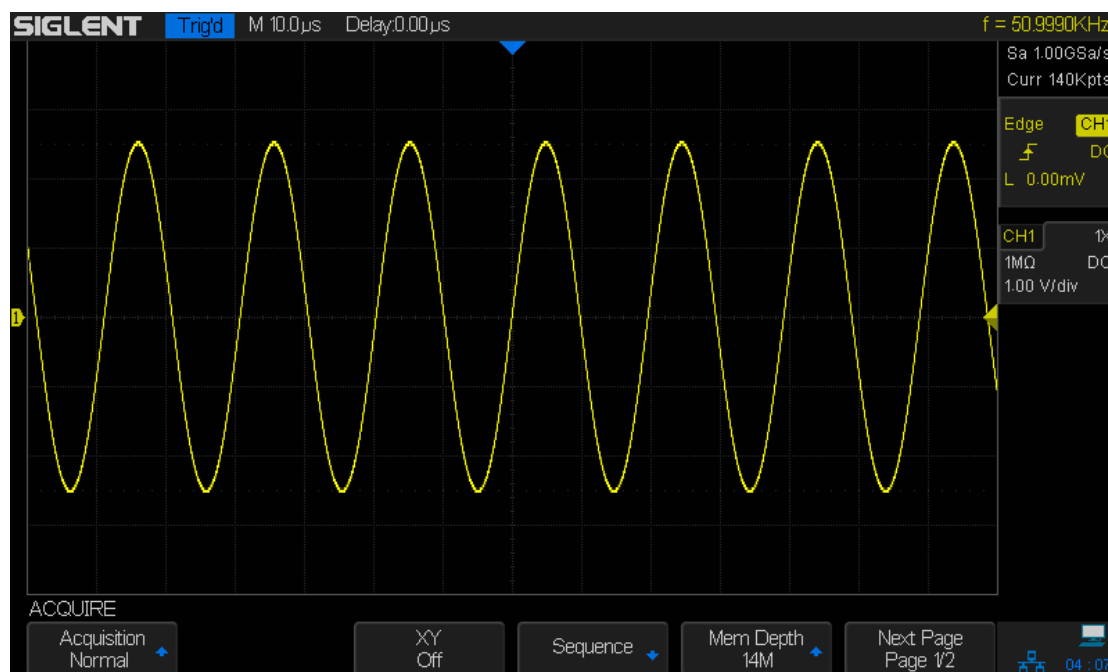

Figure 14 Acquisition System

Peak Detect

In this mode, the oscilloscope acquires the maximum and minimum values of the signal within the sample interval to get the envelope of the signal or the narrow pulse of the signal that might be lost. In this mode, signal confusion can be prevented but the noise displayed would be larger.

In this mode, the oscilloscope can display all the pulses with pulse widths at least as wide as the sample period.

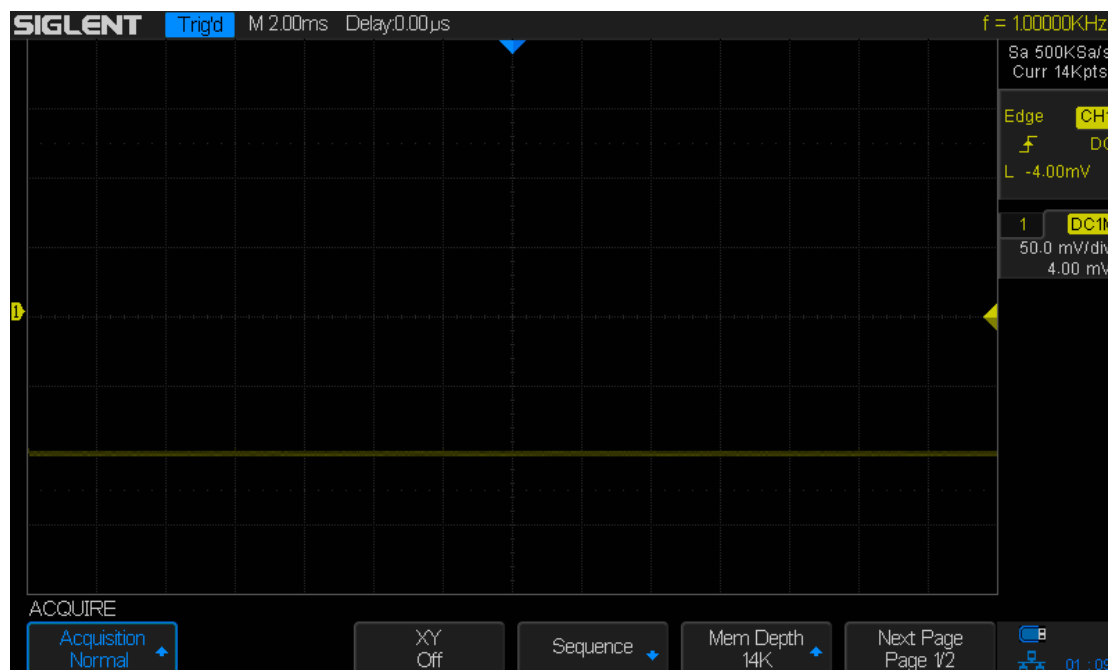

Figure 15 Pulse With 0.1% Duty, Normal Mode

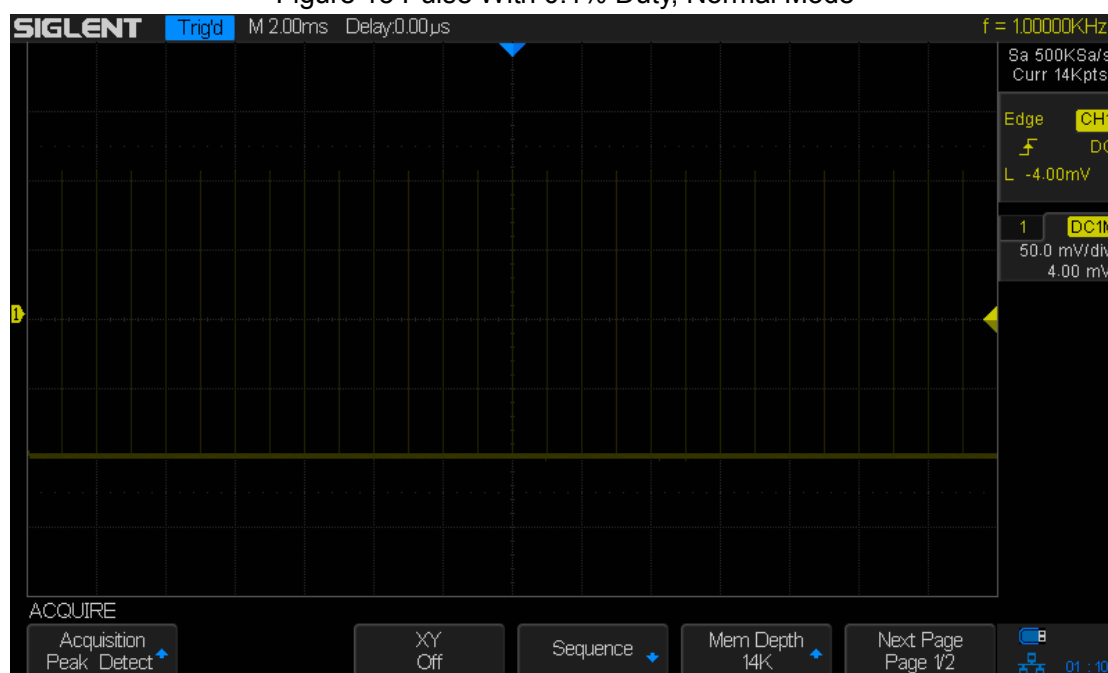

Figure 16 Pulse With 0.1% Duty, Peak Detect Mode

Average

In this mode, the oscilloscope averages the waveforms from multiple samples to reduce the random noise of the input signal and improve the vertical resolution. The greater the number of averages is, the lower the noise will be and the higher the vertical resolution will be but the slower the response of the displayed waveform to the waveform changes will be.

The available range of averages is from 4 to 1024 and the default is 16. When Average mode is selected, press **Averages** and turn the universal knob or press the softkey continually to set the desired average time.



Figure 17 With Random Noise, Normal Mode

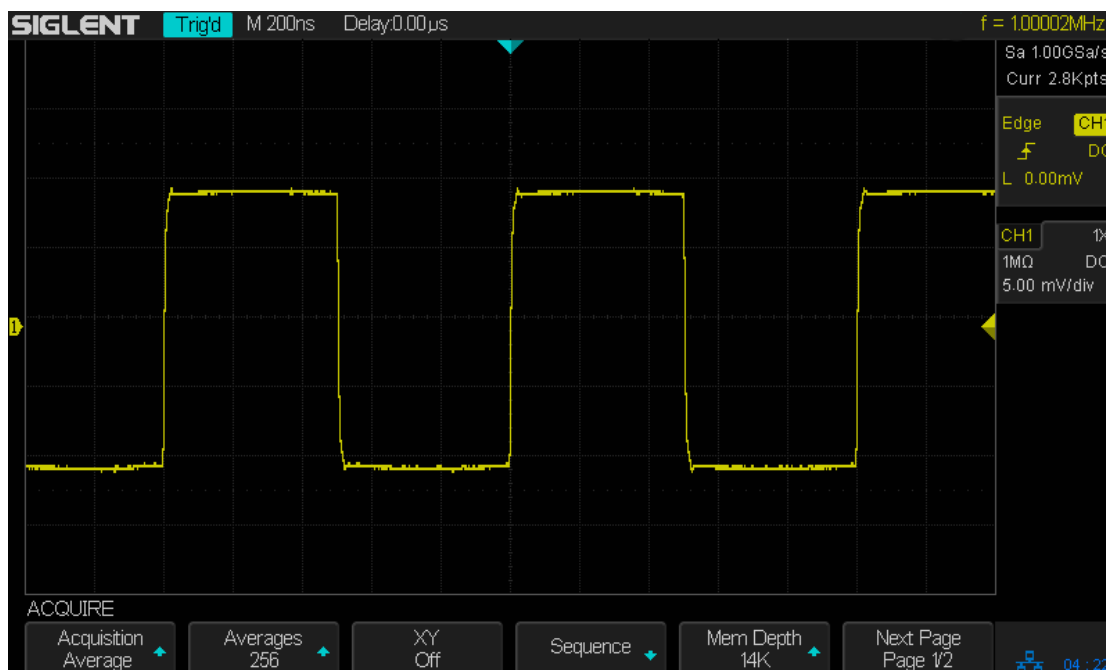

Figure 18 With Random Noise, Average Mode

High Resolution

This mode uses a kind of ultra-sample technique to average the neighboring points of the sample waveform to reduce the random noise on the input signal and generate much smoother waveforms on the screen. This is generally used when the sample rate of the digital converter is higher than the storage rate of the acquisition memory.

High Resolution mode can be used on both single-shot and repetitive signals and it does not slow waveform update. This mode limits the oscilloscope's real-time bandwidth because it effectively acts like a low-pass filter.

Note: "Average" and "High Res" modes use different averaging methods. The former uses "Waveform Average" and the latter uses "Dot Average".

Change the Horizontal Format

Press the **Acquire** button on the front panel; then press the **XY** soft key to set the XY(On) or YT(Off) mode. The default setup is **YT(Off)**.

YT

It is the normal viewing mode for the oscilloscope. In the Normal time mode, signal events occurring before the trigger are plotted to the left of the trigger point and signal events after the trigger plotted to the right of the trigger point.

XY

XY mode changes the display from a volt- versus- time display to a volt- versus- volt display. Channel 1 amplitude is plotted on the X- axis and Channel 2 amplitude is plotted on the Y- axis, the two channels will be turned on or off together.

You can use XY mode to compare frequency and phase relationships between two signals. XY mode can also be used with transducers to display strain versus displacement, flow versus pressure, volts versus current, or voltage versus frequency.

The phase deviation between two signals with the same frequency can be easily measured via Lissajous method. The figure below shows the measurement schematic diagram of the phase deviation

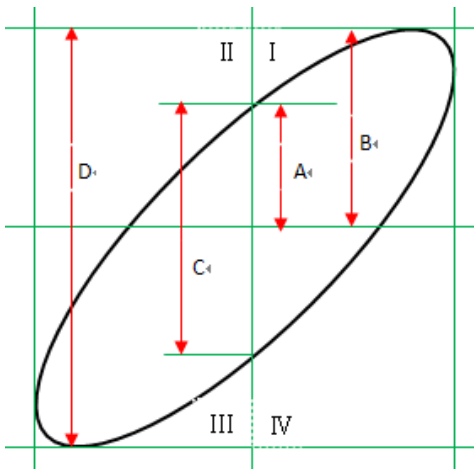

According to $\sin\theta=A/B$ or C/D (wherein, θ is the phase deviation angle between the two channels and the definitions of A, B, C and D are as shown in the figure above), the phase deviation angle is obtained, that is: $\theta=\pm\arcsin(A/B)$ or $\pm\arcsin(C/D)$

If the principal axis of the ellipse is within quadrant I and III, the phase deviation angle obtained should be within quadrant I and IV, namely within $(0$ to $\pi/2)$ or $(3\pi/2$ to $2\pi)$. If the principal axis of the ellipse is within quadrant II and IV, the phase deviation angle obtained should be within quadrant II and III, namely within $(\pi/2$ to $\pi)$ or $(\pi$ to $3\pi/2)$.

X-Y function can be used to measure the phase deviation occurred when the signal under test passes through a circuit network. Connect the oscilloscope to the circuit to monitor the input and output signals of the circuit.

Use Sequence Mode

Sequence is also a kind of acquisition mode, which does not display waveform during sampling process. It improves the waveform capture rate, and the maximal capture rate is more than 300,000 wfs/s. So it can capture the small probability event effectively.

The oscilloscope runs and fills a memory segment for each trigger event. The oscilloscope is busy acquiring multiple segments. The oscilloscope continues to trigger until memory is filled, and then display the waveforms on the screen.

To use the sequence mode, the HORIZONTAL Format must be set to **YT**.

Do the following steps to use the sequence mode.

1. Press the **Acquire** button on the front panel to enter the ACQUIRE function menu;
2. Press the **Sequence** softkey to enter the SEQUENCE function menu.



Figure 19 SEQUENCE Function Menu

3. Press the **Segments Set** softkey; and then turn the **Universal Knob** to select the desired value.
 - The **Segments Set** display format is A/B, A is the frame number you set by turning the **Universal Knob** and B is the maximal number that you can set under the time base.

Do the following steps to replay the sequence waveform under history mode:

1. Press the **History** softkey to enable HISTORY function .

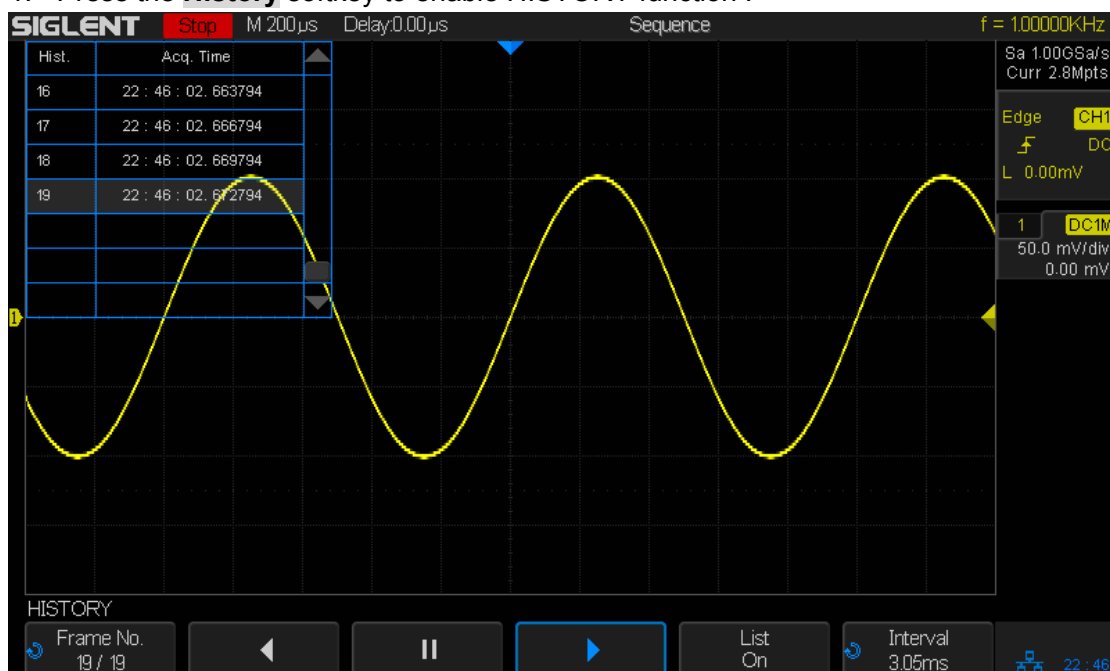





Figure 20 HISTORY Function Menu

2. Press the **List** softkey to turn on the list display. The list records the acquisition time of every frame and shows the frame number that displaying on the screen.
3. Press the **Frame No.** softkey; and then turn the **Universal Knob** to select the frame to display.
4. Press the  softkey to replay the waveform from the current frame to 1.
5. Press the  softkey to stop replay.
6. Press the  softkey to replay the waveform from the current frame to the last frame.

To Trigger the Oscilloscope

For trigger, you set certain trigger condition according to the requirement and when a waveform in the waveform stream meets this condition, the oscilloscope captures this waveform as well as the neighboring part and displays them on the screen. For digital oscilloscope, it displays waveform continuously no matter whether it is stably triggered, but only stable trigger can ensure stable display. The trigger circuit ensures that every time base sweep or acquisition starts from the input signal and the user-defined trigger condition, namely every sweep is synchronous to the acquisition and the waveforms acquired overlap to display stable waveform.

The following is the schematic diagram of the acquisition memory. As shown in the figure below, the position of the trigger event is determined by the reference time point and the delay setting.

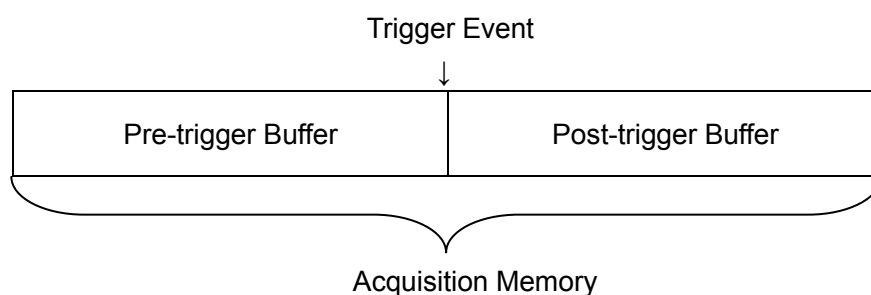

Trigger setting should be based on the features of the input signal, thus you need to have some knowledge of the signal under test to quickly capture the desired waveform.

SDS1000X provides abundant advanced trigger functions which can help you to focus on the desired waveform details. These trigger types are edge, slope, pulse, video, window, interval, dropout, runt, pattern and serial trigger. This chapter will mainly introduce all these trigger functions which mentioned above in details and tell you how to set the trigger conditions to capture desired waveform.

The contents of this chapter:

- ◆ Trigger Source
- ◆ Trigger Mode
- ◆ Trigger Level
- ◆ Trigger Coupling
- ◆ Trigger Holdoff
- ◆ Noise Rejection
- ◆ Trigger Type
 - Edge Trigger
 - Slope Trigger
 - Pulse Trigger
 - Video Trigger
 - Window Trigger
 - Interval trigger
 - DropOut Trigger
 - Runt Trigger
 - Pattern Trigger

Trigger Source

SDS1000X trigger source includes analog channels (**CH1**, **CH2**), **EXT**, **EXT/5** and **AC Line**.

Press the **Setup** button on the front panel to enter the TRIGGER function menu; press the **Source** softkey and then turn the **Universal Knob** to select the desired trigger source.

The current trigger source is displayed at the upper right corner of the screen. Select channel with signal input as trigger source to obtain stable trigger.

Analog channel input:

Signals input from analog channels **CH1** and **CH2** can all be used as the trigger source. No matter whether the input of the channel selected is enabled, the channel can work normally.

External trigger input:

External trigger source can be used to connect external trigger signal to the EXT TRIG channel when all of the four channels are sampling data. The trigger signal (such as external clock and signal of the circuit to be tested) will be connected to **EXT** and **EXT/5** trigger source via the **[EXT TRIG]** connector. **EXT/5** trigger source attenuates the signal by a factor of 5. It extends the trigger level. You can set the trigger condition within the range of trigger level (-8 div to +8 div).

AC line:

The trigger signal is obtained from the AC power input of the oscilloscope. This kind of signals can be used to display the relationship between signal (such as illuminating device) and power (power supply device). For example, it is mainly used in related measurement of the power industry to stably trigger the waveform output from the transformer of a transformer substation.

Note: to select stable channel waveform as the trigger source to stabilize the display.

Trigger Mode

SDS1000X trigger mode includes auto, normal and single. Trigger mode affects the way in which the oscilloscope searches for the trigger

After the oscilloscope starts running, the oscilloscope operates by first filling the pre-trigger buffer. It starts searching for a trigger after the pre-trigger buffer is filled and continues to flow data through this buffer while it searches for the trigger. While searching for the trigger, the oscilloscope overflows the pre-trigger buffer and the first data put into the buffer is first pushed out (First Input First Out, FIFO).

When a trigger is found, the pre- trigger buffer contains the events that occurred just before the trigger. Then, the oscilloscope fills the post- trigger buffer and displays the acquisition memory.

Press the **Auto**, **Normal** and the **Single** buttons on the front panel to select the desired trigger mode, and the corresponding status light will be lighted.

- In the **Auto** trigger mode (the default setting), if the specified trigger conditions are not found, triggers are forced and acquisitions are made so that signal activity is displayed on the oscilloscope.

The **Auto** trigger mode is appropriate when:

- Checking DC signals or signals with unknown levels or activity.
- When trigger conditions occur often enough that forced triggers are unnecessary.

- In the **Normal** trigger mode, triggers and acquisitions only occur when the specified trigger conditions are found. Otherwise, the oscilloscope holds the original waveform and waits for the next trigger.

The **Normal** trigger mode is appropriate when:

- You only want to acquire specific events specified by the trigger settings.
- Triggering on an infrequent signal from a serial bus (for example, I2C, SPI, CAN, LIN, etc.) or another signal that arrives in bursts. The **Normal** trigger mode lets you stabilize the display by preventing the oscilloscope from auto- triggering.

- In the Single trigger mode, the oscilloscope waits for a trigger and displays the waveform when the trigger condition is met and then stops.

The **Single** trigger mode is appropriate when:

- To capture single event or aperiodic signal.
- To capture burst or other unusual signals.

Trigger Level

Trigger level and slope define the trigger point,

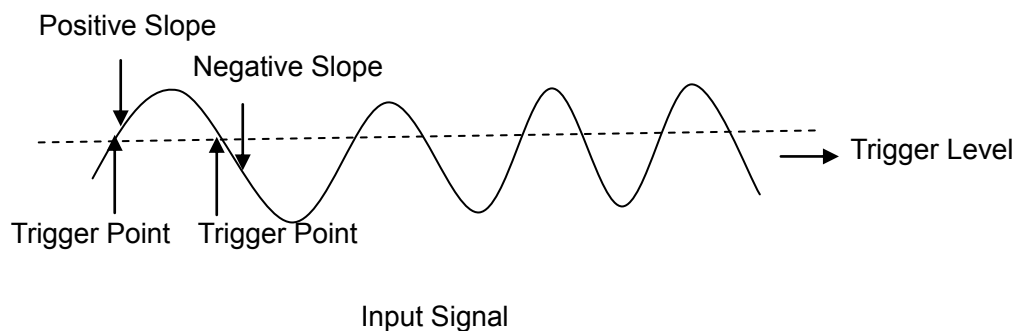

You can adjust the trigger level for a selected analog channel by turning the **Trigger Level Knob**.

You can push the **Trigger Level Knob** to set the level to the waveform's 50% value immediately. If AC coupling is used, pushing the **Trigger Level knob** sets the trigger level to about 0 V.

The position of the trigger level for the analog channel is indicated by the trigger level icon ◀ (If the analog channel is on) at the left side of the display. The value of the analog channel trigger level is displayed in the upper- right corner of the display.

Trigger Coupling

Press the **Setup** button on the front panel to enter the TRIGGER function menu, and then press the **Coupling** softkey and turn the **Universal Knob** or press the **Coupling** softkey continually to select the desired coupling mode.

SDS1000X provides 4 kinds of trigger coupling modes:

- **DC**: allow DC and AC components into the trigger path.
- **AC**: block all the DC components and attenuate signals lower than 5.8 Hz. Use AC coupling to get a stable edge trigger when your waveform has a large DC offset.
- **LF Reject**: block the DC components and reject the low frequency components lower than 2.08MHz. Low frequency reject removes any unwanted low frequency components from a trigger waveform, such as power line frequencies, etc., that can interfere with proper triggering. Use **LF Reject** coupling to get a stable edge trigger when your waveform has low frequency noise.
- **HF Reject**: reject the high frequency components higher 1.27MHz)

Note: trigger coupling has nothing to do with the channel coupling.

Trigger Holdoff

Trigger holdoff can be used to stably trigger the complex waveforms (such as pulse series). Holdoff time is the amount of time that the oscilloscope waits before re-arming the trigger circuitry. The oscilloscope will not trigger until the holdoff time expires.

Use the holdoff to trigger on repetitive waveforms that have multiple edges (or other events) between waveform repetitions. You can also use holdoff to trigger on the first edge of a burst when you know the minimum time between bursts.

For example, to get a stable trigger on the repetitive pulse burst shown below, set the holdoff time to be >200 ns but <600 ns.

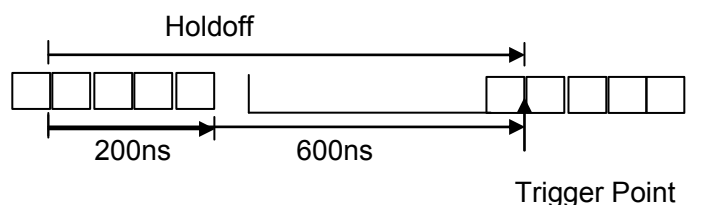

The correct holdoff setting is typically slightly less than one repetition of the waveform. Set the holdoff to this time to generate a unique trigger point for a repetitive waveform. Only edge trigger and serial trigger have holdoff option. The holdoff time of SDS1000X is adjustable from 100ns to 1.5s.

1. Press the **Stop** button, and then use the **Horizontal Position Knob** and the **Horizontal Scale Knob** to find where the waveform repeats. Measure this time using cursors; then, set the holdoff.
2. Press the **Setup** button on the front panel to enter the TRIGGER function menu. The default trigger type is edge.
3. Press the **Holdoff Close** softkey; and then turn the **Universal Knob** to set the desired holdoff time.

Note: adjust the time scale and horizontal position will not affect the holdoff time.

Noise Rejection

Noise Reject adds additional hysteresis to the trigger circuitry. By increasing the trigger hysteresis band, you reduce the possibility of triggering on noise. However, this also decreases the trigger sensitivity so that a slightly larger signal is required to trigger the oscilloscope.

Press the **Setup** button on the front panel, and then press the **Noise Reject** softkey continually to set the option to **On** or **Off** to turn on or off the noise rejection function.

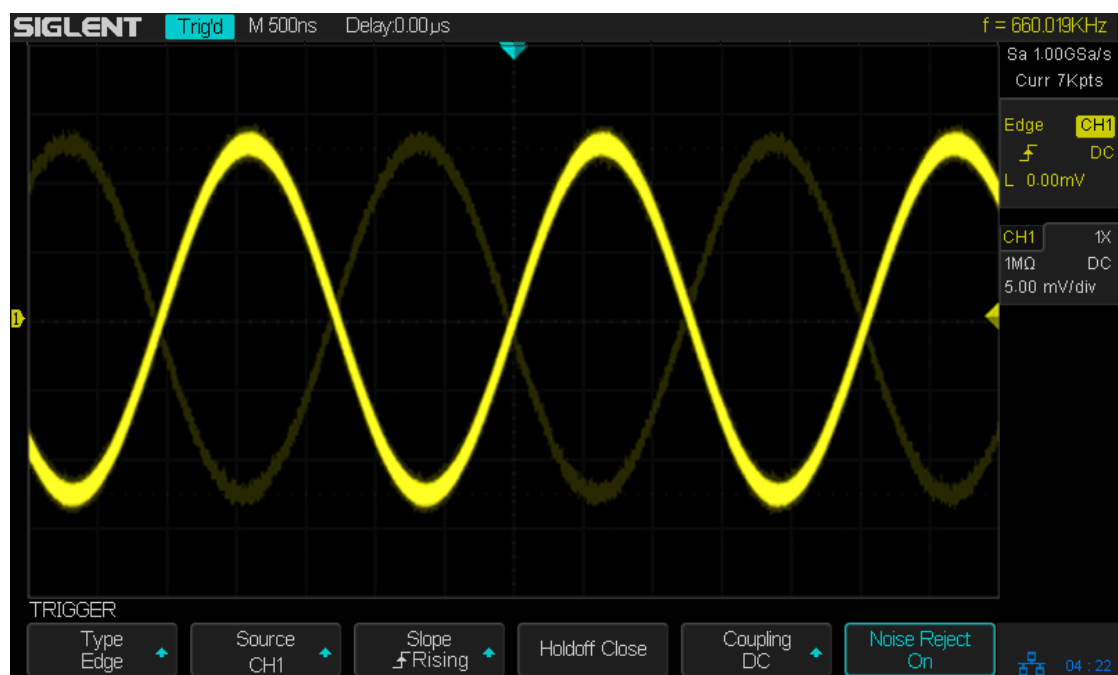

Figure 21 Turn off the Noise Reject



Figure 22 Turn on the Noise Reject

If the signal you are probing is noisy, you can set up the oscilloscope to reduce the noise in the trigger path and on the displayed waveform. First, stabilize the displayed waveform by removing the noise from the trigger path. Second, reduce the noise on the displayed waveform.

1. Connect a signal to the oscilloscope and obtain a stable display.
2. Remove the noise from the trigger path by setting trigger coupling to **LF Reject**, **HF Reject** or turning on **Noise Reject**.
3. Set the **Acquisition** option to Average to reduce noise on the displayed waveform.

Trigger Type

SDS1000X provides abundant advanced trigger functions, including various serial bus triggers.

- ◆ Edge trigger
- ◆ Slope trigger
- ◆ Pulse trigger
- ◆ Video trigger
- ◆ Window trigger
- ◆ Interval trigger
- ◆ DropOut trigger
- ◆ Runt trigger
- ◆ Pattern trigger

Edge Trigger

Edge trigger distinguishes the trigger points by seeking the specified edge (rising, falling, rising & falling) and trigger level.

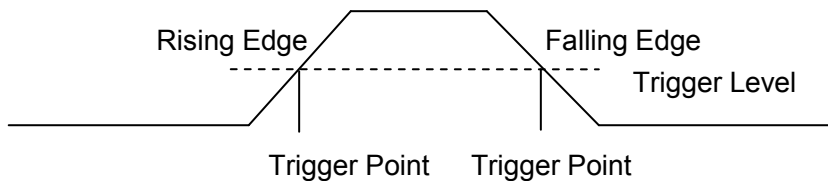

1. Press the **Setup** button on the front panel to enter the TRIGGER system function menu.
2. Press the **Type** softkey; turn the **Universal Knob** to set select **Edge** and then push the knob to confirm.
3. Press the **Source** softkey; turn the **Universal Knob** to select **CH1**, **CH2**, **EXT**, **EXT/5** or **AC Line** as the trigger source.
4. Press the **Slope** softkey; turn the **Universal Knob** to select the desired trigger edge (rising, falling or rising & falling), and then press down the knob to confirm. The current trigger slope is displayed at the upper right corner of the screen.
5. Turn the **Trigger Level Knob** to adjust the trigger level to obtain stable trigger.



Figure 23 Edge Trigger

Note: Press the **Auto Setup** button will set the trigger type to Edge and slope to rising.

Slope Trigger

The slope trigger looks for a rising or falling transition from one level to another level in greater than or less than a certain amount of time.

In SDS1000X, positive slope time is defined as the time difference between the two crossing points of trigger level line A and B with the positive edge as shown in the figure below.

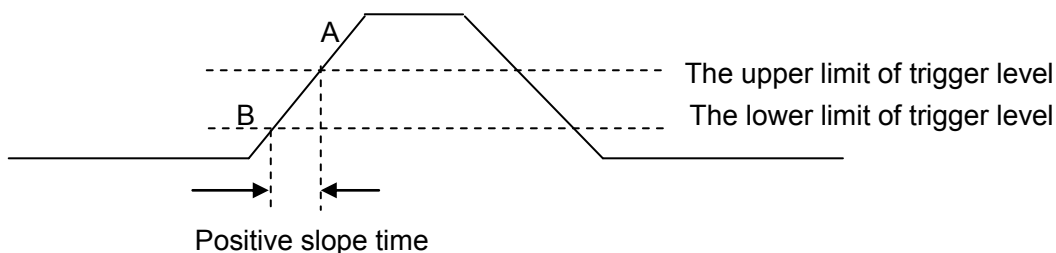

1. Press the **Setup** button on the front panel to enter the TRIGGER function menu.
2. Press the **Type** softkey; turn the **Universal Knob** to set select **Slop** and then push the knob to confirm.
3. Press the **Source** softkey; turn the **Universal Knob** to select CH1 or CH2 as the trigger source.
4. Press the Slop softkey; turn the **Universal Knob** to set select the desired trigger edge (rising or falling), and then push down the knob to confirm. The current trigger slope is displayed at the upper right corner of the screen.
5. Press **Lower Upper** softkey to select the **Lower** or **Upper** trigger level; then turn the **Trigger Level Knob** to adjust the position. The trigger level values are displayed at the upper right corner of the screen.

The lower trigger level cannot be upper than the upper trigger level. In the trigger state message box, L1 means the upper trigger lever while L2 means the lower trigger level.

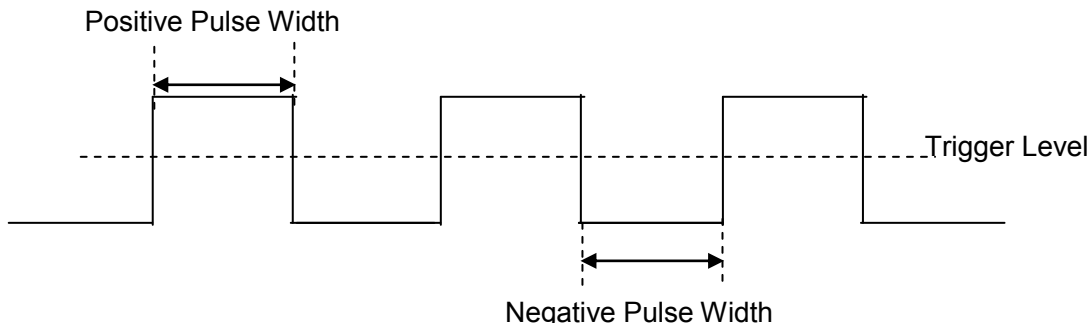

Figure 24 Slope Trigger

6. Press the **Limit Range** softkey; then turn the **Universal Knob** to select the desired slope condition, and push down the knob to confirm.
 - < (less than a time value): trigger when the positive or negative slope time of the input signal is lower than the specified time value.
 - > (greater than a time value): trigger when the positive or negative slope time of the input signal is greater than the specified time value.
 - <> (within a range of time value): trigger when the positive or negative slope time of the input signal is greater than the specified lower limit of time and lower than the specified upper limit of time value.
 - >< (outside a range of time value): trigger when the positive or negative slope time of the input signal is greater than the specified upper limit of time and lower than the specified lower limit of time value.

Pulse Trigger

Trigger on the positive or negative pulse with a specified width.



1. Press the **Setup** button on the front panel to enter the TRIGGER function menu.
2. Press the **Type** softkey; turn the **Universal Knob** to select **Pulse** and then push the knob to confirm.
3. Press the **Source** softkey; turn the **Universal Knob** to select CH1 or CH2 as the trigger source.
4. Turn the **Trigger Level Knob** to adjust the trigger level to the desired place.
5. Press the **Polarity** softkey to select **Positive** or **Negative** pulse that to trigger on. The current trigger polarity is displayed at the upper right corner of the screen.
6. Press the **Limit Range** softkey; turn the **Universal Knob** to select the desired condition.

- < (less than a time value): trigger when the positive or negative pulse time of the input signal is lower than the specified time value.
For example, for a positive pulse, if you set t (pulse real width) $< 100\text{ns}$, the waveform will trigger.



- > (greater than a time value): trigger when the positive or negative pulse time of the input signal is greater than the specified time value.
For example, for a positive pulse, if you set t (pulse real width) $> 100\text{ns}$, the waveform will trigger.



- $< >$ (within a range of time value): trigger when the positive or negative pulse time of the input signal is greater than the specified lower limit of time and lower than the specified upper limit of time value.

For example, for a positive pulse, if you set t (pulse real width) $> 100\text{ns}$ and $< 300\text{ns}$, the waveform will trigger.

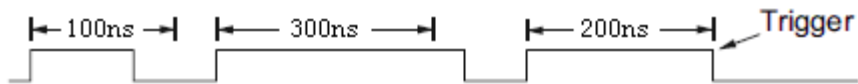

- $> <$ (outside a range of time value): trigger when the positive or negative pulse time of the input signal is greater than the specified upper limit of time and lower than the specified lower limit of time value.

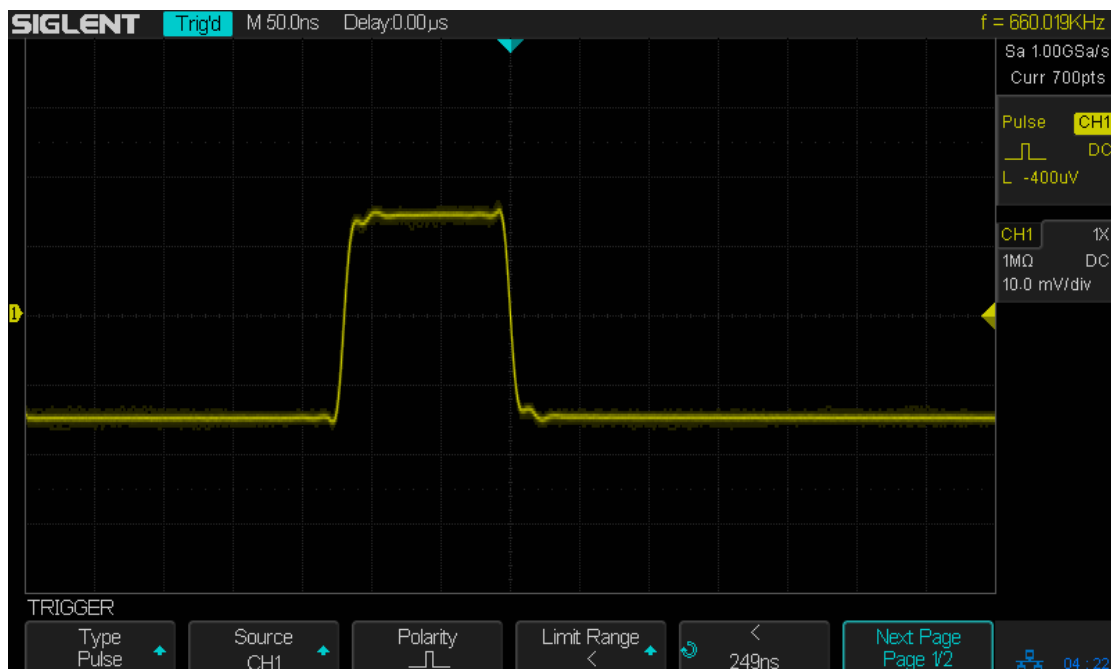

Figure 25 Pulse Trigger

Video Trigger

Video triggering can be used to capture the complicated waveforms of most standard analog video signals. The trigger circuitry detects the vertical and horizontal interval of the waveform and produces triggers based on the video trigger settings you have selected. SDS1000X supports standard video signal field or line of NTSC (National Television Standards Committee), PAL (Phase Alternating Line) HDTV (High Definition Television) and custom video signal trigger.

1. Press the **Setup** button on the front panel to enter the TRIGGER function menu.
2. Press the **Type** softkey; then turn the **Universal Knob** to select **Video** and push down the knob to confirm.
3. Press the **Source** softkey; turn the **Universal Knob** to select CH1 or CH2 as the trigger source. Turn the **Trigger Level Knob** does not change the trigger level because the trigger level is automatically set to the sync pulse.
4. Press the **Standard** softkey to select the desired video standard. SDS1000X supports the following video standards.

Standard	Type	Sync Pulse
NTSC	Interlaced	BI-level
PAL	Interlaced	BI-level
HDTV 720P/50	Progressive	Tri-level
HDTV 720P/60	Progressive	Tri-level
HDTV 1080P/50	Progressive	Tri-level
HDTV 1080P/60	Progressive	Tri-level
HDTV 1080i/50	Progressive	Tri-level
HDTV 1080i/50	Progressive	Tri-level
Custom		

The table below shows the parameters of the Custom video trigger.

Frame Rate	25Hz, 30Hz, 50Hz, 60Hz	
Of Lines	300~2000	
Of Fields	1, 2, 3, 4	
Interlace	1:1, 2:1, 4:1, 8:1	
Trigger Position	Line	Field
	(line value)/1	1
	(line value)/2	2
	(line value)/3	3
	(line value)/4	4
	(line value)/5	5
	(line value)/6	6
	(line value)/7	7
	(line value)/8	8

The table below takes **Of Lines** as 800 as an example to explain the relation between **Of Lines, Of Fields, Interlace, Trigger Line** and **Trigger Field**.

Of Lines	Of Fields	Interlace	Trigger Line	Trigger Field
800	1	1:1	800	1
800	1,2,4 or 8	2:1	400	1, 1~2, 1~4, 1~8
800	1,2,4 or 8	4:1	200	1, 1~2, 1~4, 1~8
800	1,2,4 or 8	8:1	100	1, 1~2, 1~4, 1~8

- Press the **Sync** softkey to select **Any** or **Select** trigger mode.
 - Any**: trigger on any of the horizontal sync pulses
 - Select**: trigger on the appointed line and field you have set. Press the Line or Field softkey; then turn the **Universal Knob** to set the value.

The following table lists the line numbers per field for each video standard.

Standard	Field 1	Field 2
NTSC	1 to 262	1 to 263
PAL	1 to 312	1 to 313
HDTV 720P/50, HDTV 720P/60	1 to 750	
HDTV 1080P/50, HDTV 1080P/60	1 to 1125	
HDTV 1080iP/50, HDTV 1080i/60	1 to 562	1 to 563

The following are exercises to familiarize you with video triggering.

- To trigger on a specific line of video
- To use Custom video trigger

To Trigger on a Specific Line of Video

Video triggering requires greater than 1/2 division of sync amplitude with any analog channel as the trigger source.

The example below set to trigger on field 2, line 124 using the NTSC video standard.

- Press the **Setup** button on the front panel to enter the TRIGGER system function menu.
- Press the **Type** softkey; then use the **Universal Knob** to select Video and push down the knob to confirm.
- Press the **Source** softkey; turn the Universal Knob to select CH1 as the trigger source, and press the knob to confirm.
- Press the **Standard** softkey; turn the Universal Knob to select NTSC, and press the knob to confirm.
- Press the **Sync** softkey and set the option to **Select**; press the **Line** softkey and then turn the universal to select **022** and push the knob to confirm; press the **Field** softkey and then turn the **Universal Knob** to select **1** and push the knob to confirm

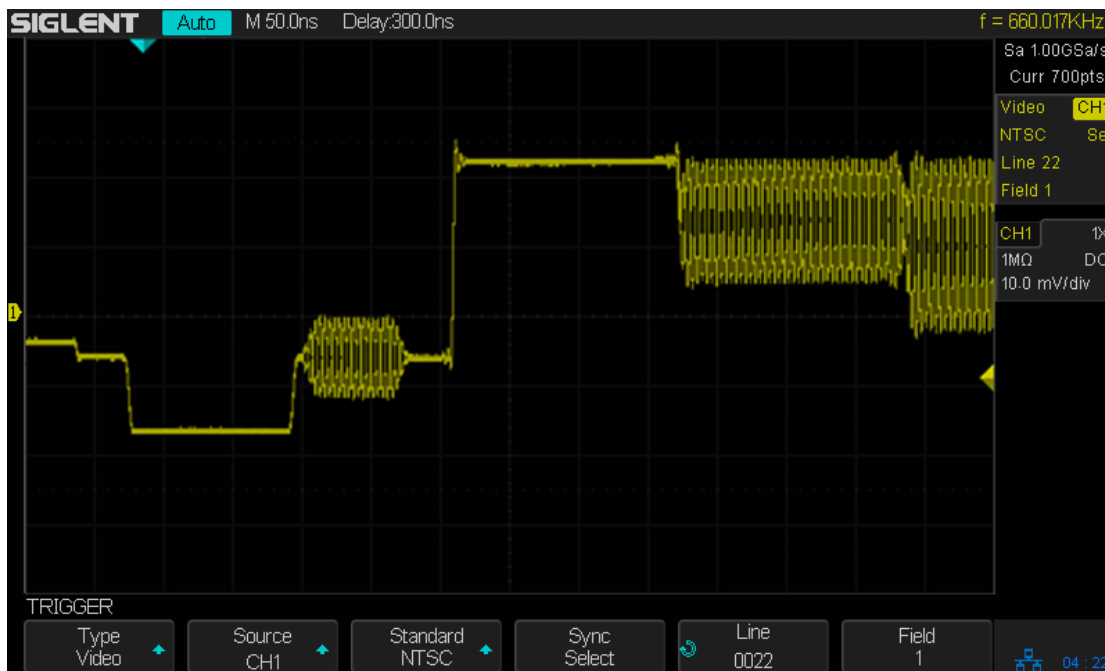

Figure 26 Video Trigger

To Use Custom Video Trigger

Custom video trigger supports frame rate of 25Hz, 30Hz, 50Hz and 60Hz, and the line range is available from 300 to 2000. The steps below show how to set custom trigger.

1. Press the **Setup** button on the front panel to enter the TRIGGER function menu.
2. Press the **Type** softkey; then use the **Universal Knob** to select **Video** and push down the knob to confirm.
3. Press the **Source** softkey; turn the **Universal Knob** to select **CH1** as the trigger source, and push down the knob to confirm.
4. Press the **Standard** softkey; turn the **Universal Knob** to select **Custom**, and push down the knob to confirm.
5. Press the **Setting** softkey to enter the custom setting function menu. Press the **Interlace** softkey; turn the **Universal Knob** to select the desired value.
6. Press the **Of Field** softkey; turn the **Universal Knob** to select the desired value.
7. Press the **Sync** softkey to enter the TRIG ON menu to set the line and field.
 - Press the Type softkey to select **Select** or **Any**.
 - If the **Type** option set to **Select**, press the Line softkey; turn the **Universal Knob** to select the desired value. Press the **Field** softkey; turn the **Universal Knob** to select the desired value.

Window Trigger

Windows trigger provides a high trigger level and a low trigger level. The instrument triggers when the input signal passes through the high trigger level or the low trigger level.

There are two kinds of window types: Absolute and Relative. They have different trigger level adjustment methods. Under Absolute window type, the lower and the upper trigger levels can be adjusted respectively via the Level knob; under Relative window type, adjust the Center value to set the window center; adjust the Delta value to set the window range, the lower and the upper trigger levels always move together.

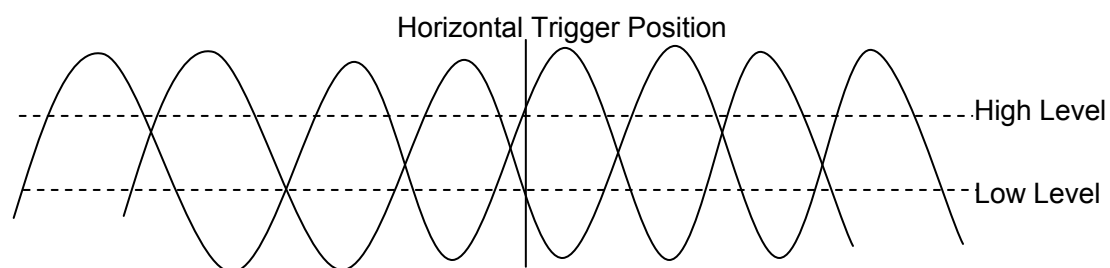

- If the lower and the upper trigger levels are both within the waveform amplitude range, the oscilloscope will trigger on both rising and falling edge.
- If the upper trigger level is within the waveform amplitude range while the lower trigger level is out of the waveform amplitude range, the oscilloscope will trigger on rising edge only.
- If the lower trigger level is within the waveform amplitude range while the upper trigger level is out of the waveform amplitude range, the oscilloscope will trigger on falling edge only.

To set window trigger via Absolute window type:

1. Press the **Setup** button on the front panel to enter the TRIGGER function menu.
2. Press the **Type** softkey; then use the **Universal Knob** to select **Window** and push down the knob to confirm.
3. Press the **Source** softkey; turn the **Universal Knob** to select CH1 or CH2 as the trigger source.
4. Press the **Window Type** softkey to select Absolute.
5. Press the **Lower Upper** softkey to select **Lower** or **Upper** trigger level; then turn the **Trigger Level Knob** to adjust the position. The trigger level values are displayed at the upper right corner of the screen.

The Lower trigger level cannot be upper than the upper trigger level. In the trigger state message box, **L1** means the upper trigger level while **L2** means the lower trigger level.

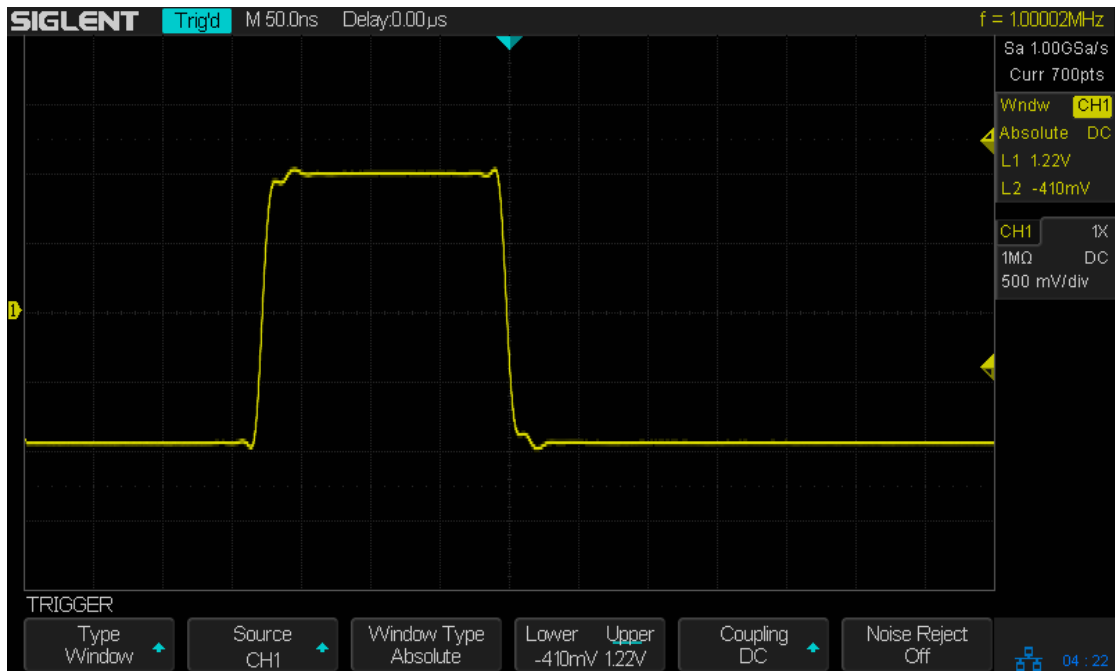

Figure 27 Absolute Window Trigger

To set window trigger via Relative window type:

1. Press the **Setup** button on the front panel to enter the TRIGGER system function menu.
2. Press the **Type** softkey; then use the **Universal Knob** to select **Window** and push down the knob to confirm.
3. Press the **Source** softkey; turn the **Universal Knob** to select CH1 or CH2 as the trigger source.
4. Press the **Window Type** softkey to select **Relative**.
5. Press the **Center Delta** softkey to select **Center** or **Delta** trigger level mode; then turn the **Trigger Level Knob** to adjust the position. The **Center** and **Delta** values are displayed at the upper right corner of the screen.

In the trigger state message box, **C** means **Center**, the center value of the lower and upper trigger levels; **D** means **Delta**, the difference between the lower (or upper) trigger level and the trigger level center.

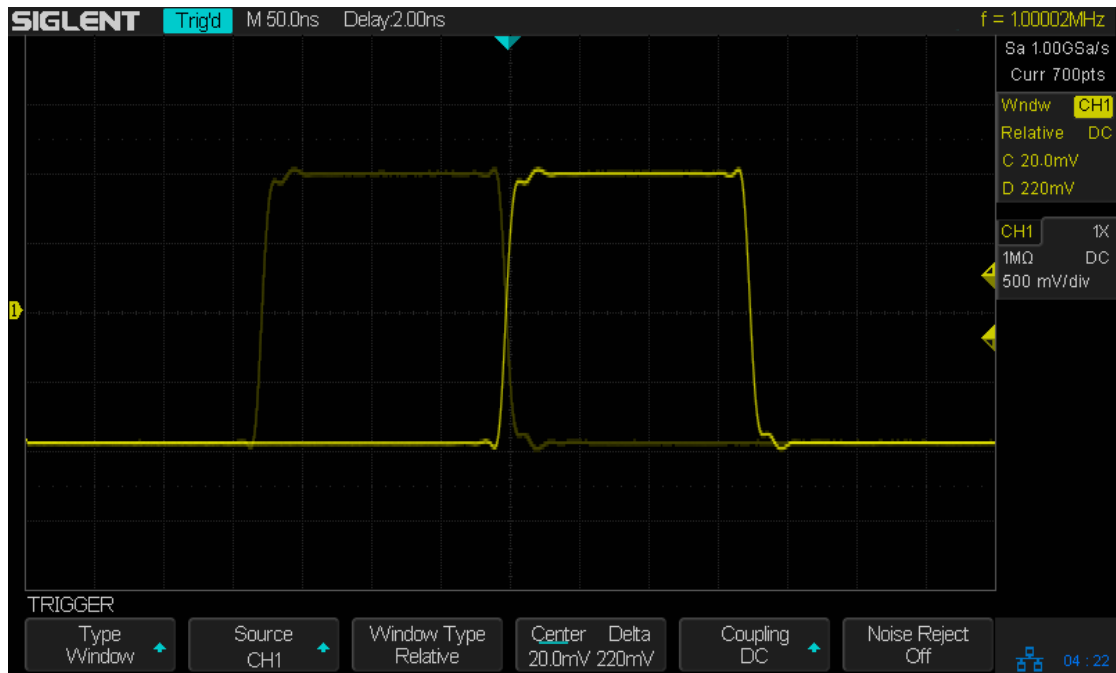
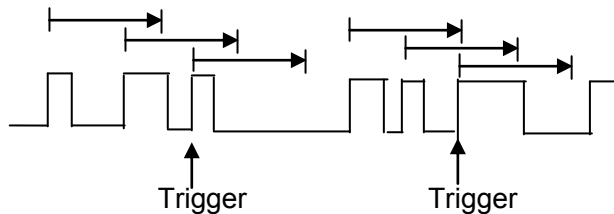

Figure 28 Relative Window Trigger

Interval Trigger

Trigger when the times difference between the neighboring rising or falling edges meets the time limit (<, >, <>, ><).



To set interval trigger:

1. Press the **Setup** button on the front panel to enter the TRIGGER system function menu.
2. Press the **Type** softkey; then use the **Universal Knob** to select **Interval** and push down the knob to confirm.
3. Press the **Source** softkey; turn the **Universal Knob** to select CH1 or CH2 as the trigger source.
4. Press the **Slope** softkey to select rising or falling edge.
5. Press the **Limit Range** softkey; turn the **Universal Knob** to select desired condition.
 - < (less than a time value): trigger when the positive or negative pulse time of the input signal is lower than the specified time value.
 - > (greater than a time value): trigger when the positive or negative pulse time of the input signal is greater than the specified time value.
 - < > (within a range of time value): trigger when the positive or negative pulse time of the input signal is greater than the specified lower limit of time and lower than the specified upper limit of time value.
 - > < (outside a range of time value): trigger when the positive or negative pulse time of the input signal is greater than the specified upper limit of time and lower than the specified lower limit of time value.
6. Press the **Time Setting** softkey (<, >, <>, ><), turn the **Universal Knob** to select the desired value.

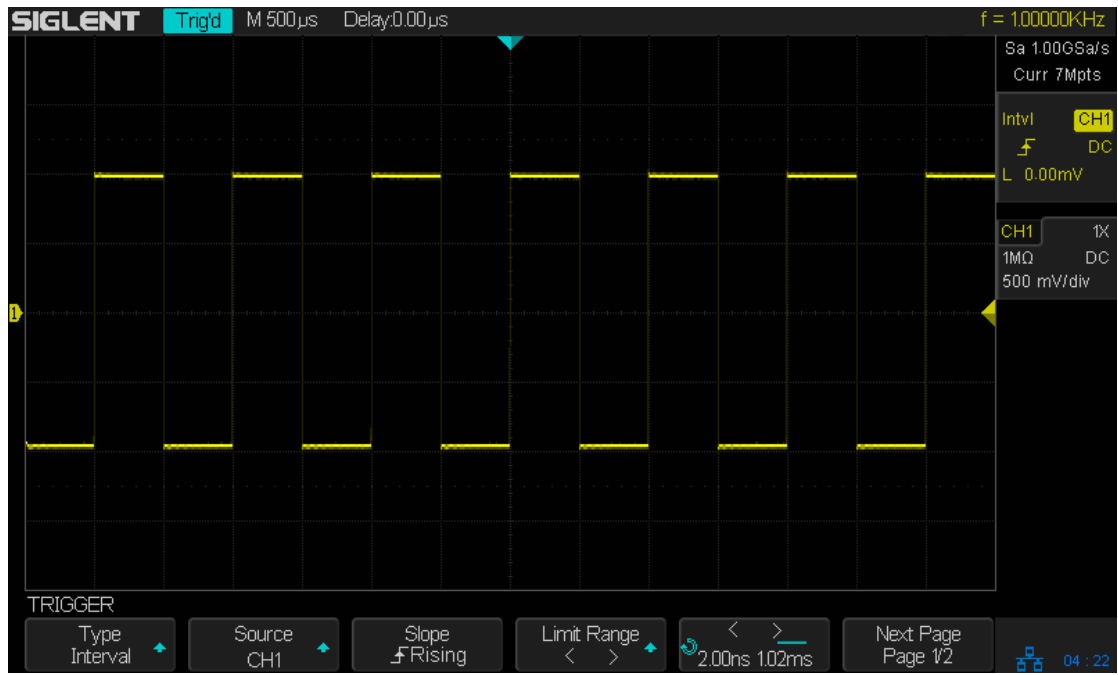

Figure 29 Interval Trigger

DropOut Trigger

DropOut trigger includes two types: edge and state.

Edge

Trigger when the time interval (ΔT) from when the rising edge (or falling edge) of the input signal passes through the trigger level to when the neighboring rising edge (or falling edge) passes through the trigger level is greater than the timeout time set, as shown in the figure below.

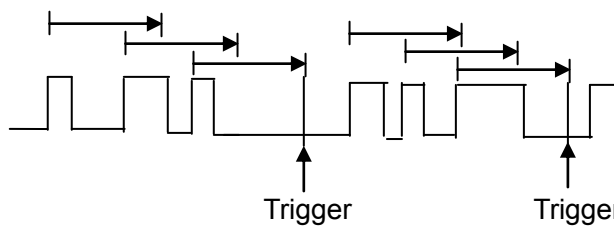

State

Trigger when the time interval (ΔT) from when the rising edge (or falling edge) of the input signal passes through the trigger level to when the neighboring falling edge (or rising edge) passes through the trigger level is greater than the timeout time set, as shown in the figure below.

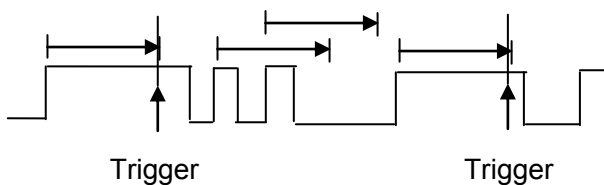

To set edge DropOut trigger:

1. Press the **Setup** button on the front panel to enter the TRIGGER system function menu.
2. Press the **Type** softkey; then use the **Universal Knob** to select **DropOut** and push down the knob to confirm.
3. Press the **Source** softkey; turn the **Universal Knob** to select CH1 or CH2 as the trigger source. The current trigger source is displayed at the upper right corner of the screen. Select channel with signal input as trigger source to obtain stable trigger.
4. Press the **Slope** softkey to select rising or falling edge.
5. Press the **OverTime Type** softkey to select **Edge**.
6. Press the **Time** softkey; turn the universal to select the desired value.

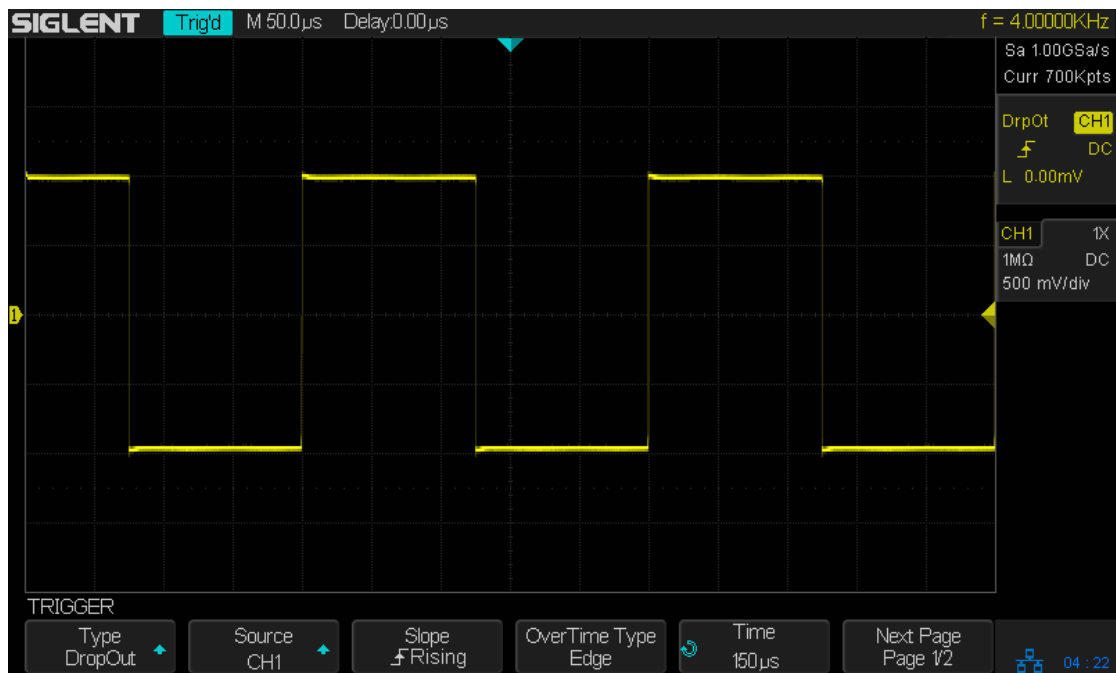

Figure 30 Edge DropOut Trigger

To set state DropOut trigger:

1. Press the **Setup** button to enter the TRIGGER system function menu.
2. Press the **Type** softkey; then turn the **Universal Knob** to select **DropOut** and push down the knob to confirm.
3. Press the **Source** softkey; turn the **Universal Knob** to select CH1 or CH2 as the trigger source.
4. Press the **Slope** softkey to select rising or falling edge.
5. Press the **OverTime** Type softkey to select State.
6. Press the **Time** softkey; turn the **Universal Knob** to select the desired value.

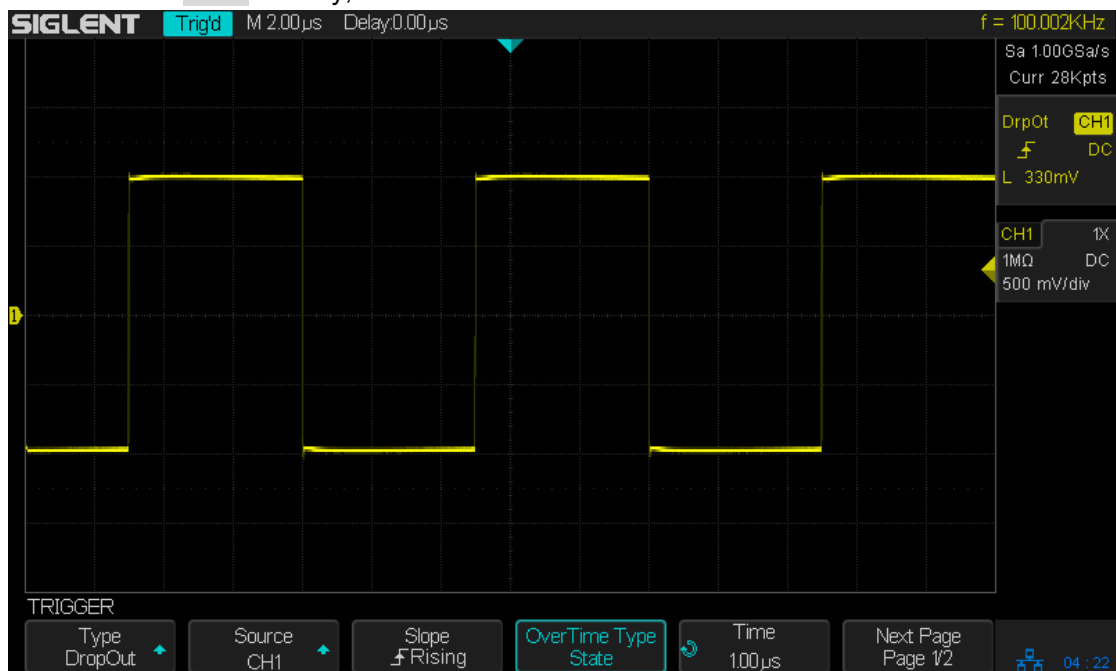
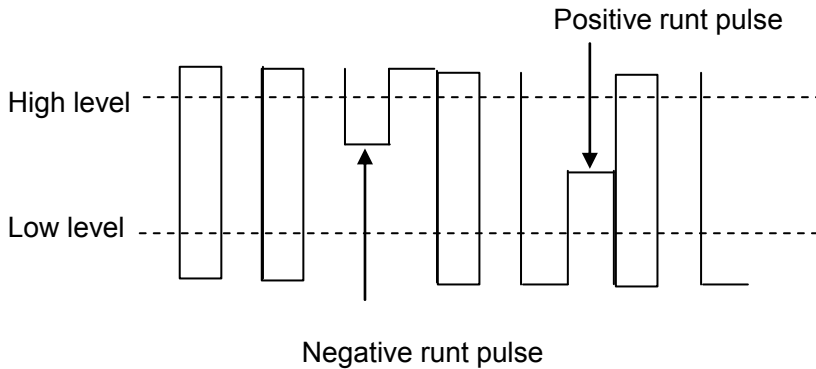

Figure 31 State DropOut Trigger

Runt Trigger

The Runt trigger looks for pulses that cross one threshold but not another as shown in the picture below.



- A positive runt pulse across through a lower threshold but not an upper threshold.
- A negative runt pulse across through an upper threshold but not a lower threshold.

To trigger on runt pulse:

1. Press the **Setup** button on the front panel to enter the **TRIGGER** system function menu.
2. Press the **Type** softkey; then turn the **Universal Knob** to select **DropOut** and push down the knob to confirm.
3. Press the **Source** softkey; turn the **Universal Knob** to select CH1 or CH2 as the trigger source.
4. Press the **Polarity** softkey to select **Positive** or **Negative** pulse to trigger.
5. Press the **Limit Range** softkey; turn the **Universal Knob** to select the desired condition (<, >, <> or ><).
6. Press the **Time Setting** softkey, and then turn the **Universal Knob** to select the desired value.
7. Press the **Next Page** softkey to enter the second page of the TRIGGER system function menu. Press the **Lower Upper** softkey to select **Lower** or **Upper** trigger level, and then turn the **Universal Knob** to set the position.

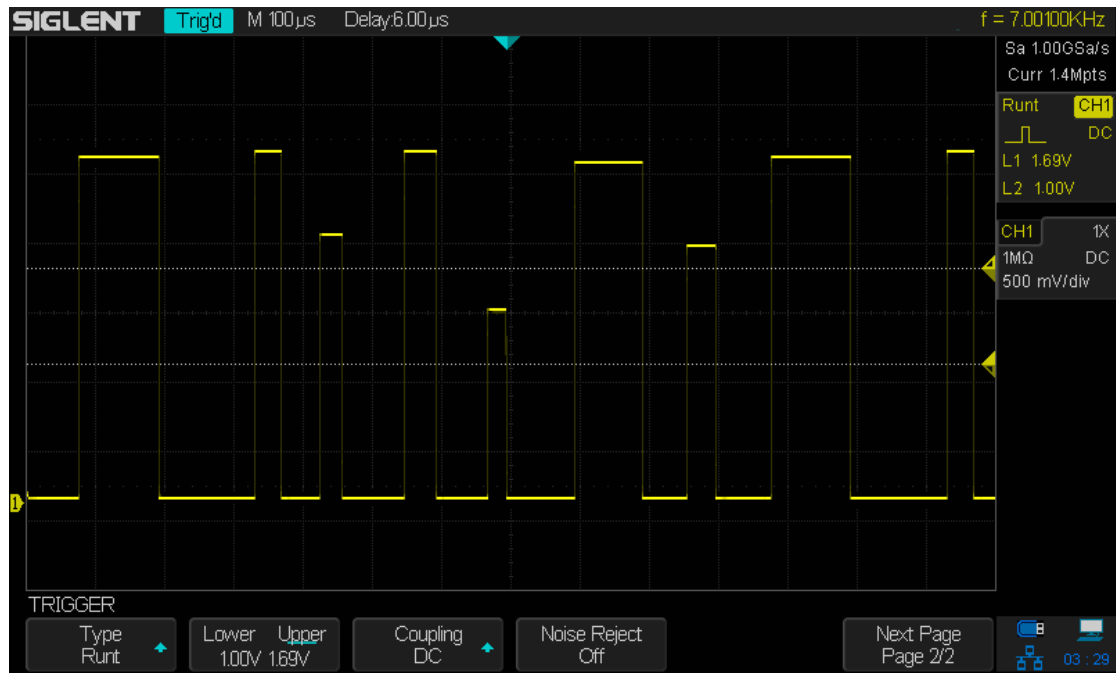
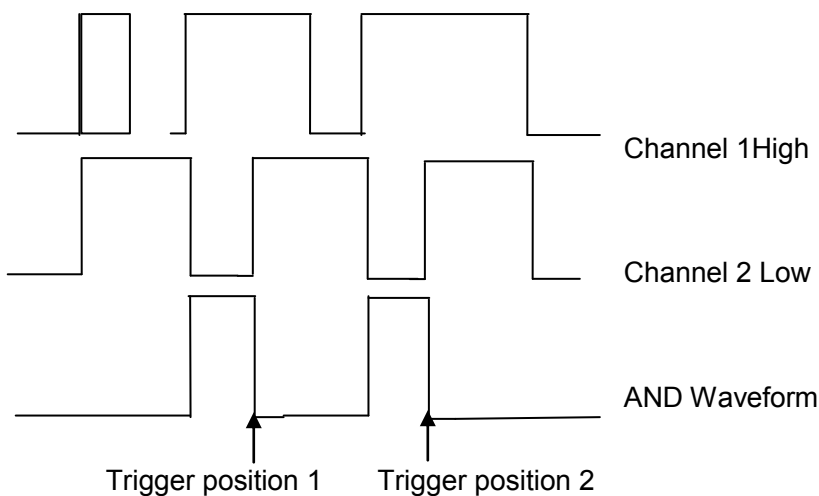

Figure 32 Runt Trigger

Pattern Trigger

The Pattern trigger identifies a trigger condition by looking for a specified pattern. The pattern trigger can be expanded to incorporate delays similar to other triggers. Pattern durations are evaluated using a timer. The timer starts on the last edge that makes the pattern “true”. Potential triggers occur on the first edge that makes the pattern false, provided that the time qualifier criterion has been met. SDS1000X provides 4 patterns: logical AND, OR, NAND and NOR combination of the channels. Each channel can set to low, high or invalid.



Do the following steps to set pattern trigger:

1. Press the **Setup** button on the front panel to enter the TRIGGER function menu.
2. Press the **Type** softkey; turn the **Universal Knob** to select Pattern, and then push down the knob to confirm.
3. Press each channel softkey to select **Invalid**, **High** or **Low**.
 - **Low** sets the pattern to low on the selected channel. A low is a voltage level that is less than the channel's trigger level or threshold level.
 - **High** sets the pattern to high on the selected channel. A high is a voltage level that is greater than the channel's trigger level or threshold level.
 - **Invalid** sets the pattern to don't care on the selected channel. Any channel set to don't care is ignored and is not used as part of the pattern.
However, if all channels in the pattern are set to **Invalid**, the oscilloscope will not trigger.
Adjust the trigger level for the selected analog channel by turning the Trigger Level knob. **Invalid** doesn't need to set trigger level.
4. Press the **Next Page** softkey to enter the second page of the pattern trigger menu.
5. Press the **Logic** softkey and then turn the **Universal Knob** to select the desired logic combination **AND**, **OR**, **NAND** or **NOR**.
6. Press the **Limit Range** softkey; then turn the **Universal Knob** to select the desired option.
 - **< (Less Than)** – when the pattern is present for less than a time value.

- **> (Greater Than)** – when the pattern is present for greater than a time value. The trigger occurs
 - **>< (In Range)** – when the pattern is present for a time within a range of values.
 - **<> (Out of Range)** – when the pattern is present for a time outside of range of values.
7. Press the **Holdoff Close** softkey to turn on the Holdoff function; then turn the **Universal Knob** to select the desired value.

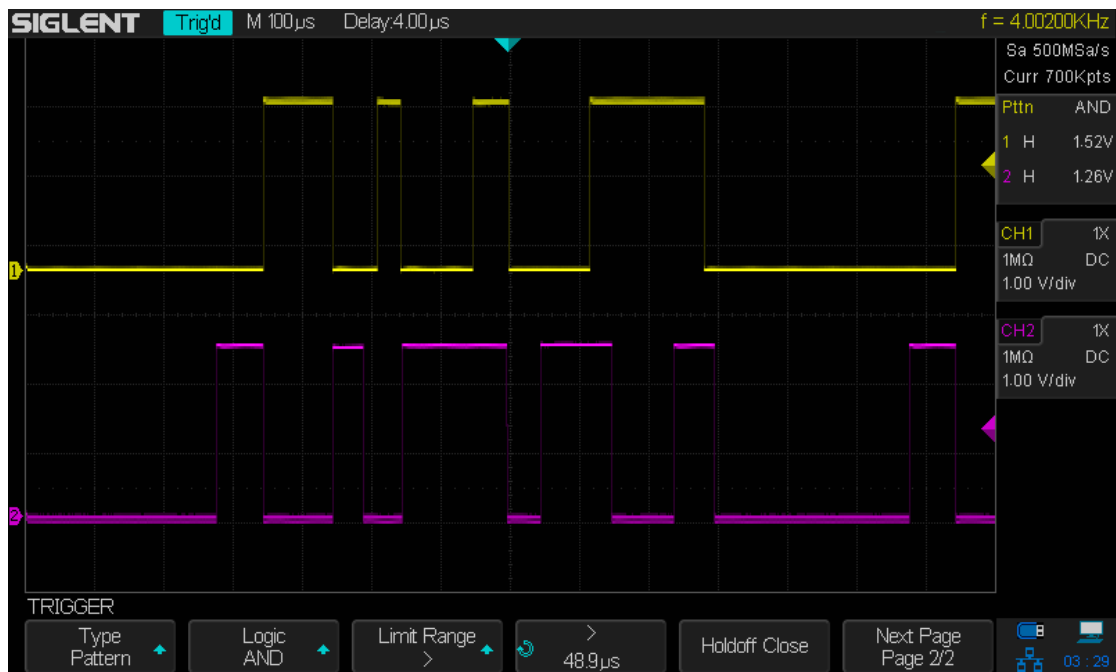

Figure 33 Pattern Trigger

Serial trigger and decode

SDS1000X provides IIC, SPI, UART/RS232, CAN and LIN serial trigger and decode. This chapter introduces how to set every kind of serial trigger and decode in details.

The contents of this chapter:

- ◆ IIC Trigger and Decoder
- ◆ SPI Trigger and Decoder
- ◆ UART/RS232 Trigger and Decoder
- ◆ CAN Trigger and Decoder
- ◆ LIN Trigger and Decoder

IIC Trigger and Serial Decode

Please take the order of “**Setup for IIC Signals**”, “**IIC Triggering**” and “**IIC Decode**” to trigger and decode the signals.

Setup for IIC Signals

IIC (Inter- IC bus) signals setup consists of connecting the oscilloscope to the serial data (SDA) line and the serial clock (SCL) line and then specifying the input signal threshold voltage levels.

To set up the oscilloscope to capture IIC signals, use the **Signal** softkey which appears in the Decode Menu:

1. Press the **Decode** button on the front panel to turn on the DECODE function menu.
2. Press the **Serial** softkey and select the desired slot (Serial 1 or Serial 2).
3. Press the **Decode** option and select IIC with the **Universal Knob**, and then push down the **Universal Knob** to confirm.



Figure 34 IIC SINGAL Menu

4. Press **Signal** softkey to enter the IIC SIGNAL menu.
 5. For both the SCL (serial clock) and SDA (serial data) signals:
 - a. Connect an oscilloscope channel to the signal in the device under test.
 - b. Press the **SCL** or **SDA** softkey; then, turn the Universal Knob to select the channel for the signal.
 - c. Press the corresponding **Threshold** softkey; then, turn the Universal Knob to set the signal threshold voltage level.
- The threshold voltage level is used in decoding, and it will become the trigger level when the trigger type is set to the selected serial decode slot.
 - Data must be stable during the whole high clock cycle or it will be interpreted as a start or stop condition (data transitioning while the clock is high).

IIC Triggering

After the oscilloscope has been set up to capture IIC signals, you can trigger on a stop/start condition, a restart, a missing acknowledge, an EEPROM data read, a read/write frame with a specific device address and data value, or on a data length.

1. Press the button **Setup** on the front panel to enter trigger function menu.
2. Press the **Type** softkey; then, turn the **Universal Knob** to select the serial slot (**Serial 1** or **Serial 2**) on which the IIC signals are being decoded above.

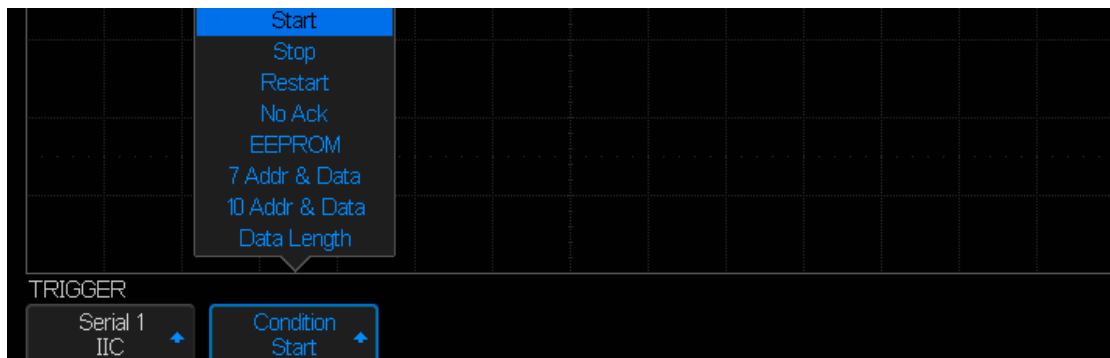
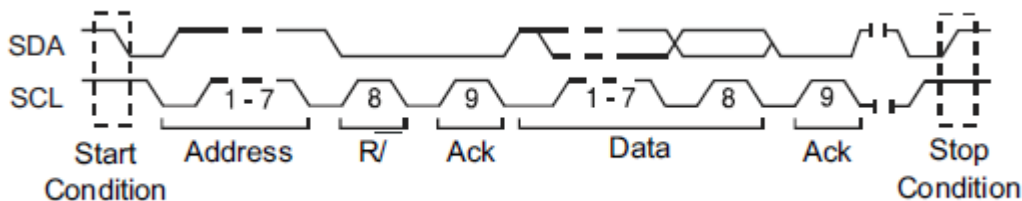
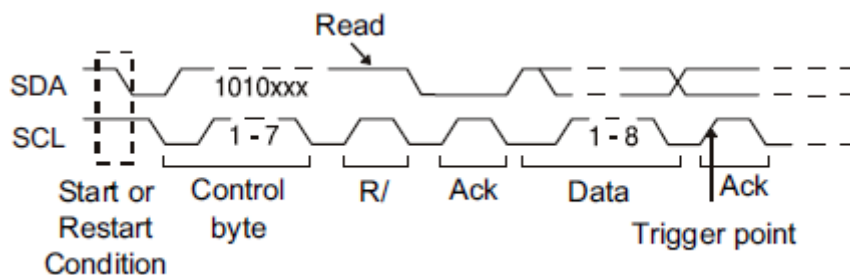

Figure 35 IIC TRIGGER Menu

3. Press the **Condition** softkey; then, turn the Universal Knob to select the trigger condition:
 - **Start Condition**— The oscilloscope triggers when SDA data transitions from high to low while the SCL clock is high. For triggering purposes (including frame triggers), a restart is treated as a start condition.
 - **Stop Condition**— The oscilloscope triggers when data (SDA) transitions from low to high while the clock (SCL) is high.



- **Restart**— The oscilloscope triggers when another start condition occurs before a **stop condition**.
- **Missing Acknowledge**— The oscilloscope triggers when SDA data is high during any Ack SCL clock bit.
- **EEPROM Data Read**— The trigger looks for EEPROM control byte value 1010xxx on the SDA line, followed by a Read bit and an Ack bit. It then looks for the data value and qualifier set by the **Limit Range** softkey and the **Data1** softkey. When this event occurs, the oscilloscope will trigger on the clock edge for the Ack bit after the data byte. This data byte does not need to occur directly after the control byte.



- **7-bit Address & Data Condition** —The oscilloscope triggers on a read or write frame in 7-bit addressing mode on the 17th or the 26th clock edge if all bits in the pattern match. For triggering purposes, a restart is treated as a start condition

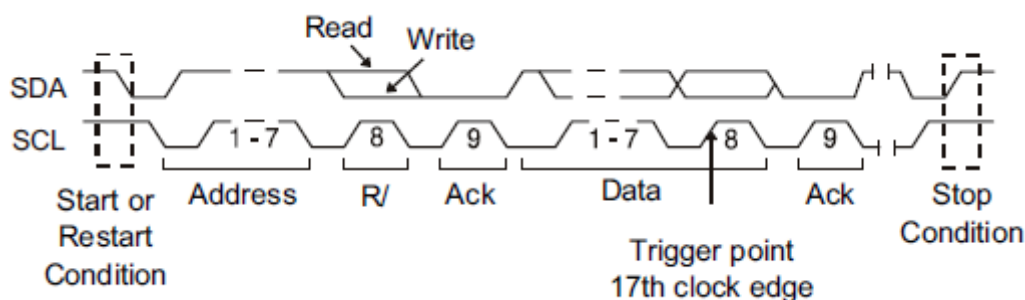

On the 17th Clock Edge

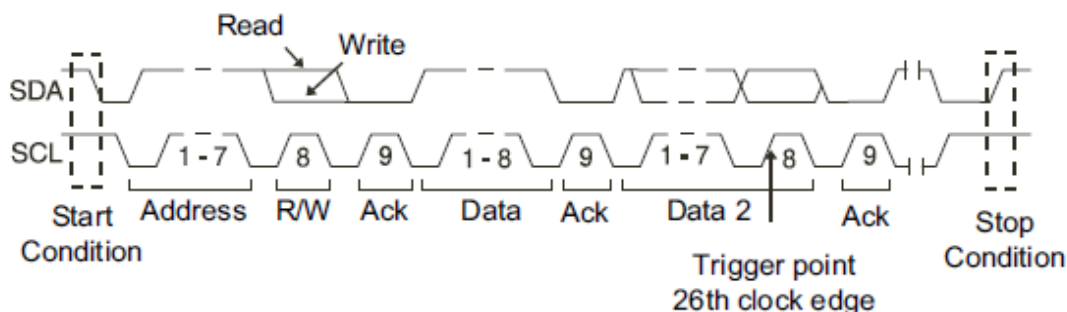

On the 26th Clock Edge

- **10-bit Address & Data Condition** — The oscilloscope triggers on a 10-bit write frame on the 26th (or 34th) clock edge if all bits in the pattern match. The frame is in the format: Frame (Start: Address byte 1: Write: Address byte 2: Ack: Data) The oscilloscope triggers on a read or write frame in 10-bit addressing mode on the 26th clock edge if all bits in the pattern match. **Data 2** shows **oxXX**. For triggering purposes, a restart is treated as a start condition.
Frame (Start: Address byte 1: Write: Address byte 2: Ack: Data: Ack: Data) The oscilloscope triggers on a read or write frame in 7-bit addressing mode on the 34th clock edge if all bits in the pattern match. **Data2** is available. For triggering purposes, a restart is treated as a start condition

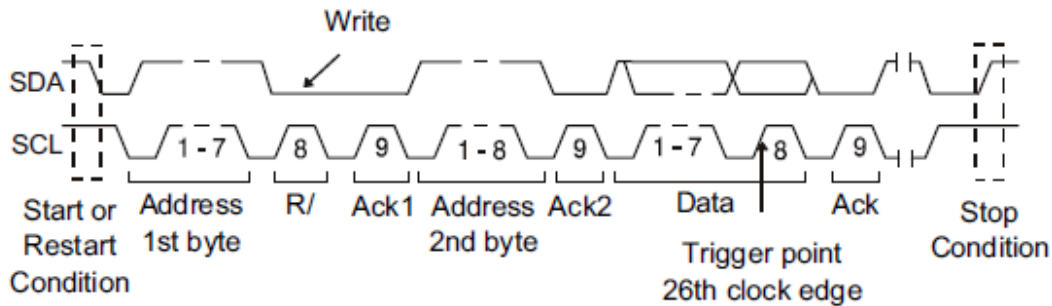

- **Data Length** — The oscilloscope triggers when the SDA data length is equal to the value set in the **Byte Length** softkey.
4. If you have set the oscilloscope to trigger on an EEPROM Data Read condition: Press the **Limit Range** softkey to set the oscilloscope to trigger when data is = (equal to), < (less than), or > (greater than) the data value set in the **Data1** softkey. The oscilloscope will trigger on the clock edge for the Ack bit after the trigger event is found. This data byte does not need to occur directly after the control byte. The oscilloscope will trigger on any data byte that meets the criteria defined by the **Byte Length** and **Data1** softkeys during a current address read or a random read or a sequential read cycle.
 5. If you have set the oscilloscope to trigger on a 7- bit address read or write frame condition or a 10- bit read or write frame condition:
 - a. Press the **Addr** softkey and turn the **Universal Knob** to select the 7- bit or 10- bit device address.
You can select from an address range of 0x00 to 0x7F (7- bit) or 0x3FF (10-bit) hexadecimal. When triggering on a read/write frame, the oscilloscope will trigger after the start, address, read/write, acknowledge, and data events occur. If don't care is selected (0xXX or 0XXX) for the address, the address will be ignored. The trigger will always occur on the 17th clock for 7- bit addressing or 26th clock for 10- bit addressing.
 - b. Press the **Data1** or **Data2** softkey and turn the **Universal Knob** to select the 8- bit data pattern on which to trigger. You can select a data value in the range of 0x00 to 0xFF (hexadecimal). The oscilloscope will trigger after the start, address, read/write, acknowledge, and data events occur.
 - c. If don't care (0xXX) is selected for data, the data will be ignored. The trigger will always occur on the 17th clock for 7- bit addressing or 26th clock for 10- bit addressing. If you have selected a three- byte trigger, press the **Data2** value softkey and turn the **Universal Knob** to select the 8- bit data pattern on which to trigger.
 6. If you have set the oscilloscope to trigger on data length condition:
 - a. Press **Address** to set the SDA address length 7bit or 10 bit.
 - b. Press **Byte Length** softkey and turn the **Universal Knob** to select the byte length.
 - c. The range of the **Byte Length** is 1 to 12.

IIC Serial Decode

To set up IIC serial decode:

1. Press **Decode** to display the DECODE function menu.



Figure 36 IIC Decode Menu

2. Press the **Address** softkey to choose 7 bit or 10 bit address size.
3. Press the **Display** softkey and choose On to display the decode line on the display.
4. Press the **List** softkey to enter the LIST function menu.
5. Press the **Display** softkey and choose On to display the decode list on the display.
6. Press the **Scroll** softkey and the **Lines** softkey to set the position of the cursor and the line number of the list with the **Universal Knob**. The range of the **Lines** is 1 to 7.

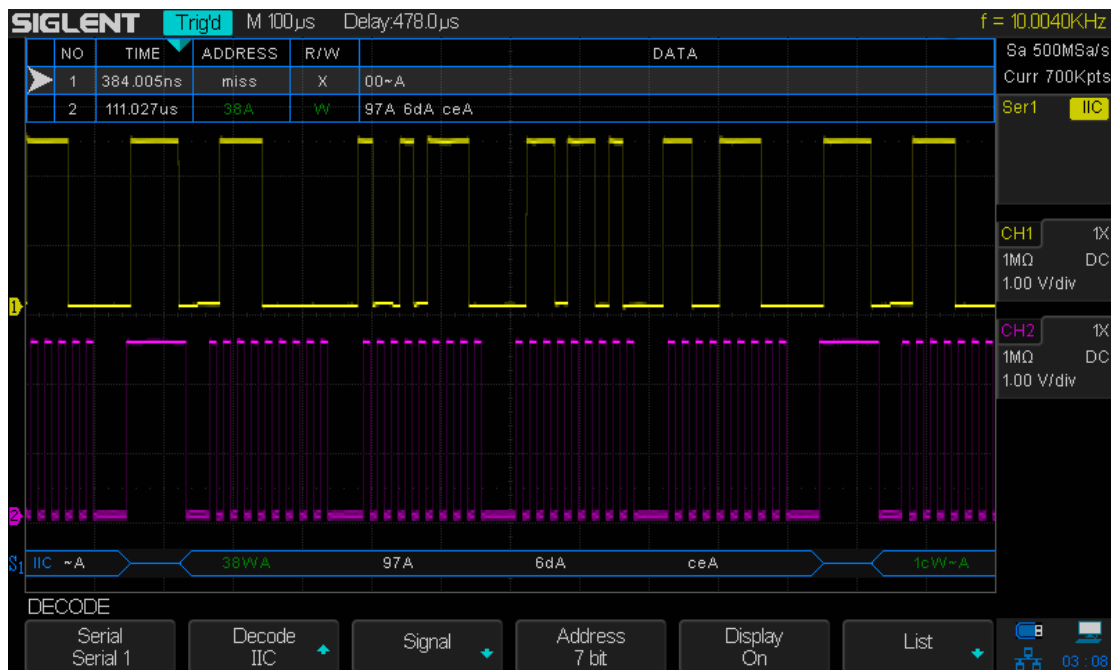

Figure 37 IIC Decode Result

Interpreting IIC Decode

- Angled waveforms show an active bus (inside a packet/frame).
- Mid-level blue lines show an idle bus.
- In the decoded hexadecimal data:
 - Address values appear at the start of a frame.
 - Write addresses appear in dark-green along with the "W" character.
 - Read addresses appear in yellow along with the "R" character.
 - Data values appear in white.
 - "A" indicates Ack (low), "~A" indicates No Ack (high).
 - Decoded text is truncated at the end of the associated frame when there is insufficient space within frame boundaries.
- Blue vertical bars indicate you need to expand the horizontal scale (and run again) to see decode.
- Red dots in the decode line indicate that more data can be displayed. Scroll or expand the horizontal scale to view the data.

Interpreting IIC Lister Data

In addition to the standard Time column, the IIC Lister contains these columns:

- NO— frame number from left to right
- Address — colored blue for writes, yellow for reads.
- R/W—yellow R for read, dark green W for write and black X for miss..
- Data — data bytes.

SPI Triggering and Serial Decode

Please take the order of “**Setup for SPI Signals**”, “**SPI Triggering**” and “**SPI Decode**” to trigger and decode the signals.

Setup for SPI Signals

Serial Peripheral Interface (SPI) signals setup consists of connecting the oscilloscope to a clock, MOSI data, MISO data, and framing signal, then setting the threshold voltage level for each input channel, and finally specifying any other signal parameters.

To set up the oscilloscope to capture SPI signals, use the **Signal** softkey which appears in the DECODE function menu:

1. Press the **Decode** button on the front panel to enter the DECODE function menu.
2. Press the **Serial** softkey and select the desired slot (Serial 1 or Serial 2).
3. Press **Decode** softkey and select **SPI** with the **Universal Knob**, and then press the knob to confirm. Serial 1 and Serial 2 could not be set to SPI at the same time. And the default setup of Serial 2 is SPI.
4. Press the **Signal** softkey to enter the SPI SIGNAL menu.



Figure 38 SPI SINGAL Menu

5. Press the **CLK** softkey to enter SPI CLK menu.



Figure 39 SPI Clock Menu

In the SPI Clock Menu:

- a. Press the **CLK** softkey; then, turn the **Universal Knob** to select the channel connected to the SPI serial clock line.
 - b. Press the **Threshold** softkey; then, turn the **Universal Knob** to select the clock signal threshold voltage level. The threshold voltage level is used in decoding, and it will become the trigger level when the trigger type is set to the selected serial decode slot.
 - c. Press the **Edge Select** softkey to select rising edge or falling edge for the selected clock source. This determines which clock edge the oscilloscope will use to latch the serial data.
6. Press the **UP** softkey to return to the SPI SINGAL menu.
 7. Press the **MISO** softkey to enter the MISO menu.



Figure 40 MOSI Menu

In the MISO menu:

- a. Press the **MISO** softkey; then, turn the **Universal Knob** to select the channel that is connected to a second SPI serial data line. (If the channel you selected is off, switch it on.)
 - b. Press the **Threshold** softkey; then, turn the **Universal Knob** to select the MISO signal threshold voltage level. The threshold voltage level is used in decoding, and it will become the trigger level when the trigger type is set to the selected serial decode slot
8. Press the **UP** softkey to return to the SPI SINGAL menu.
 9. Press the **MOSI** softkey to enter the MOSI menu.



Figure 41 MOSI Menu

In the MOSI menu:

- a. Press the **MOSI** softkey; then, turn the **Universal Knob** to select the channel that is connected to a SPI serial data line. (If the channel you selected is off, switch it on.)
 - b. Press the **Threshold** softkey; then, turn the **Universal Knob** to select the MOSI signal threshold voltage level. The threshold voltage level is used in decoding, and it will become the trigger level when the trigger type is set to the selected serial decode slot.
10. Press the **UP** softkey to return to the SPI SINGAL menu.
 11. Press the **CS** softkey to open the SPI CS menu.



Figure 42 SPI CS Menu

In the SPI CS menu:

- a. Press the **Cs Type** softkey to select a framing signal that the oscilloscope will use for determining which clock edge is the first clock edge in the serial stream. You can set the oscilloscope to trigger during a high chip select (**CS**), a low chip select (**~CS**), or after a **Timeout** period during which the clock signal has been idle.
 - If the framing signal is set to **CS** (or **~CS**), the first clock edge as defined, rising or falling, seen after the **CS** (or **~CS**) signal transitions from low to high (or high to low) is the first clock in the serial stream.
 - Press the **CS** or **~CS** softkey; then, turn the **Universal Knob** to select the channel that is connected to the SPI frame line. The label (**~CS** or **CS**) for the source channel is automatically set. The data pattern and the clock transition must occur during the time when the framing signal is valid. The framing signal must be valid for the entire data pattern.
 - If the framing signal is set to **Timeout**, the oscilloscope generates its own internal framing signal after it sees inactivity on the serial clock line.
 - **CLK Timeout** — Select **Clock Timeout** in the **Cs Type** softkey, then select the **Limit** softkey and turn the **Universal Knob** to set the minimum time that

the Clock signal must be idle (not transitioning) before the oscilloscope will search for the Data pattern on which to trigger. The **Limit** value can be set anywhere from 100 ns to 1 s.

- b. Press the **Threshold** softkey; then, turn the **Universal Knob** to select the chip select signal threshold voltage level. The threshold voltage level is used in decoding, and it will become the trigger level when the trigger type is set to the selected serial decode slot.
12. Press the **Idle Level** softkey to set idle level to **High** or **Low** according to the input signal.
 13. Press the **Bit Order** softkey to set the bit order to **LSB** or **MSB** according to the input signal.

SPI Triggering

After the oscilloscope has been set up to capture SPI signals, you can then trigger on a data pattern that occurs at the start of a frame. The serial data string can be specified to be from 4 to 96 bits long.

1. Press **Setup** button on the front panel to enter the TRIGGER function menu.
2. Press the **Type** softkey; then, turn the **Universal Knob** to select the serial slot (**Serial 1** or **Serial 2**) on which the SPI signals are being decoded above.
3. Press the **Trigger Setting** softkey to enter the SPI TRIG SET menu.



Figure 43 SPI TRIG SET Menu

4. Press the **Trigger Type** softkey to select the trigger condition.
 - **MISO DATA (Master-In, Slave-Out)** — for triggering on the MISO data signal.
 - **MOSI DATA (Master-Out, Slave-In)** — for triggering on the MOSI data signal.
5. Press the **Data Length** softkey, and turn the **Universal Knob** to set the number of bits in the serial data string. The number of bits in the string can be set anywhere from 4 bits to 96 bits. The data values for the serial string are displayed in the MISO/ MOSI data string in the waveform area.
6. For each bit in the MISO/ MOSI data string:
 - a. Press the **Bit Roll** softkey; then, turn the **Universal Knob** to select the bit location. As you rotate the Entry knob, the bit is highlighted in the Data string shown in the waveform area.
 - b. Press the **Bit Value** softkey to set the bit selected in the **Bit Roll** softkey to **0** (low), **1** (high), or **X** (don't care).
7. Press the **All Same** softkey will set all bits in the data string to **0** (low), **1** (high), or **X** (don't care) at once.
8. Press the **Bit Order** softkey to set the bit order to **LSB** (Least significant bit first) or **MSB** (Most significant bit first) which used when displaying data in the serial decode waveform and in the Lister.

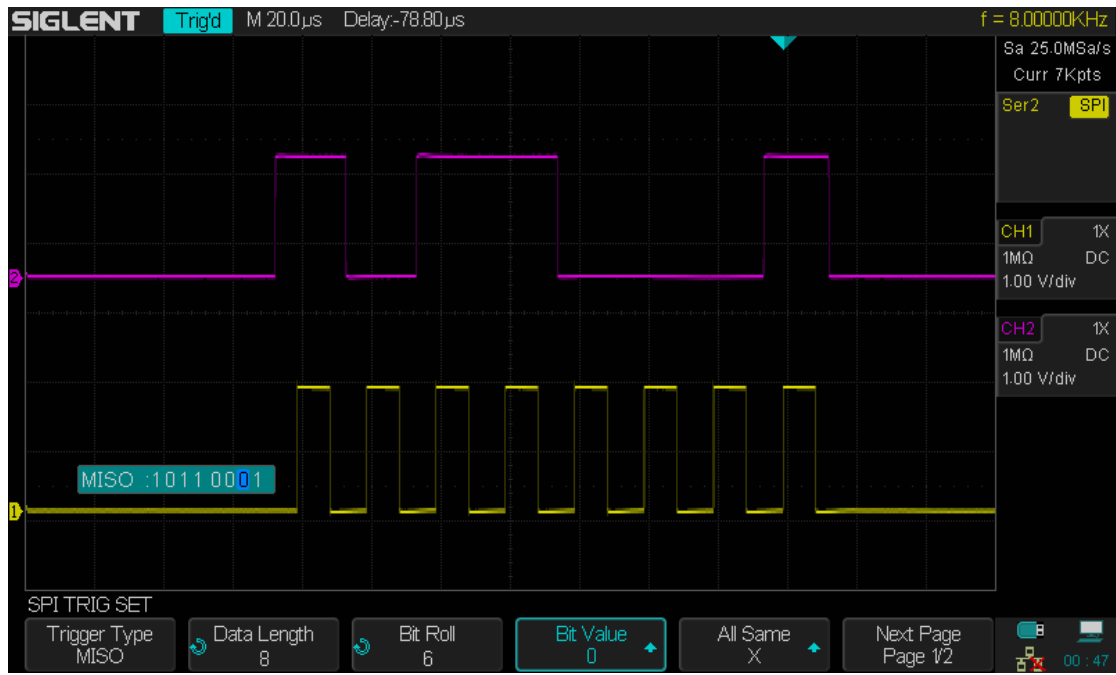

Figure 44 SPI Trigger

SPI Serial Decode

To set up SPI serial decode:

1. Press **Decode** to display the DECODE function menu.



Figure 45 SPI Decode function menu

2. Press the **Data Length** softkey, then, turn the **Universal Knob** to set the bit number of the SPI decoded data.
3. Press the **Display** softkey and choose On to display the decode line on the display.
4. Press the **List** softkey to enter the LIST function menu.
5. Press the **Display** softkey and choose **On** to display the decode list on the display.
6. Press the **Scroll** softkey and the **Lines** softkey to set the position of the cursor and the line number of the list with the **Universal Knob**. The range of the **Lines** is 1 to 7.

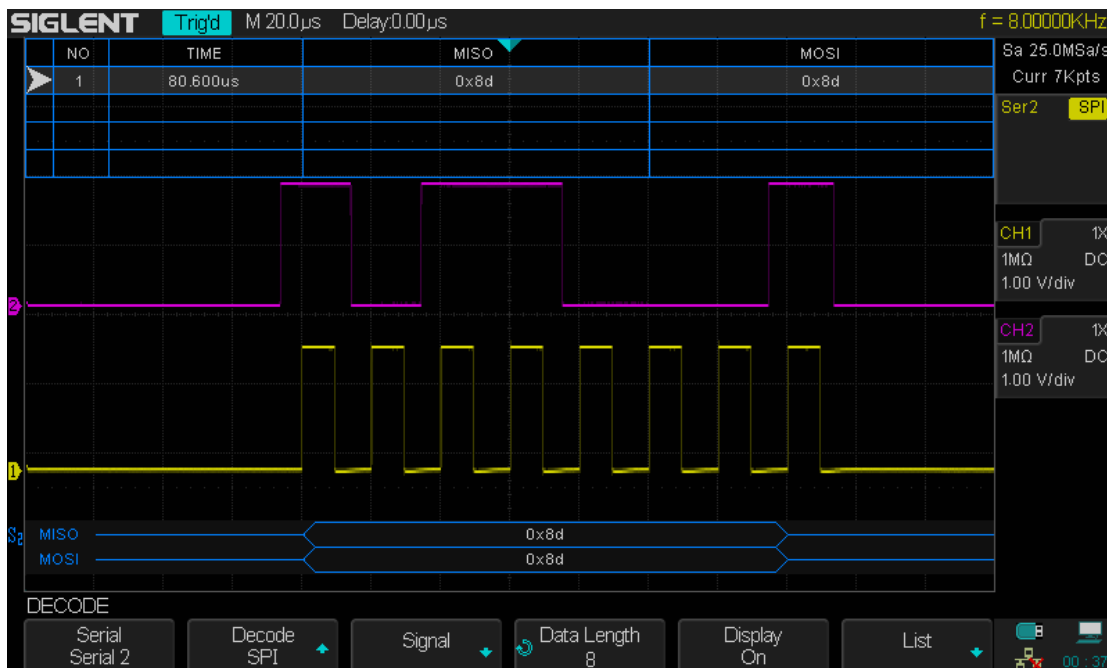

Figure 46 SPI Decode

Interpreting SPI Decode

- Angled waveforms show an active bus (inside a packet/frame).
- Mid-level blue lines show an idle bus.
- The number of clocks in a frame appears in light-blue above the frame, to the right.
- Decoded hexadecimal data values appear in white.
- Decoded text is truncated at the end of the associated frame when there is insufficient space within frame boundaries.
- Pink vertical bars indicate you need to expand the horizontal scale (and run again) to see decode.
- Red dots in the decode line indicate that there is data that is not being displayed. Scroll or expand the horizontal scale to view the information.
- Aliased bus values (undersampled or indeterminate) are drawn in pink.
- Unknown bus values (undefined or error conditions) are drawn in red.

Interpreting SPI Lister Data

In addition to the standard Time column, the SPI Lister contains these columns:

- NO— frame number from left to right.
- MISO — Data for MISO decode.
- MOSI — Data for MOSI decode.

UART/RS232 Triggering and Serial Decode

Please take the order of “**Setup for UART/RS232 Signals**”, “**UART/RS232 Triggering**” and “**UART/RS232 Decode**” to trigger and decode the signals.

Setup for UART/RS232 Signals

To set up the oscilloscope to capture UART/RS232 signals:

1. Press **Decode** on the front panel to turn on the DECODE function menu.
2. Press **Serial** and select the desired slot (Serial 1 or Serial 2).
3. Press **Decode** option and select **UART/RS232** with the **Universal Knob**, and then push down **Universal Knob** to confirm.
4. Press the **Signal** softkey to enter the UART/RS232 SIGNAL menu.



Figure 47 UART SIGNAL Menu

5. For both the Rx and Tx signals:
 - a. Connect an oscilloscope channel to the signal in the device under test.
 - b. Press the **Rx** or **Tx** softkey to select the channel for the signal.
 - c. Press the corresponding **Threshold** softkey; then, turn the **Universal Knob** to select the signal threshold voltage level. The threshold voltage level is used in decoding, and it will become the trigger level when the trigger type is set to the selected serial decode slot.
6. Press the **UP** softkey to return to the DECODE menu.
7. Press the **Configure** softkey to open the UART/RS232 BUS CONFIG menu. Set the following parameters.



Figure 48 BUS CONFIG Menu

- **Baud** — Press the **Baud** softkey, then press the **Universal Knob** and select a baud rate to match the signal in your device under test. If the desired baud rate is not listed, select **Custom** on the **Baud** softkey, and then press the **Custom** softkey and turn the **Universal Knob** to set the desired baud rate. You can set the UART baud rate to 115200b/s at most.
- **Parity Check**— Choose odd, even, or none, based on your device under test.
- **Stop Bit**—Set the number of stop bits in the UART/RS232 words to match your device under test.
- **Data Length**— Set the number of bits in the UART/RS232 words to match your device under test (selectable from 5- 8 bits).

UART/RS232 Triggering

To trigger on a UART (Universal Asynchronous Receiver/Transmitter) signal connect the oscilloscope to the Rx and Tx lines and set up a trigger condition. RS232 (Recommended Standard 232) is one example of a UART protocol.

1. Press **Setup** button on the front panel to enter the TRIGGER function menu.
2. Press the **Type** softkey; then, turn the **Universal Knob** to select the serial slot (**Serial 1** or **Serial 2**) on which the UART/RS232 signals are being decoded above.
3. Press the **Trigger** Setting softkey to enter the UART TRIG SET menu.



Figure 49 UART TRIG SET Menu

4. Press the **Source Type** softkey to select TXDATA or RX DATA.
5. Press the **Trigger** softkey and set up the desired trigger condition:
 - **Start** — The oscilloscope triggers when a start bit occurs.
 - **Stop** — Triggers when a stop bit occurs on Rx. vice under test uses 1, 1.5, •
 - **Data** — Triggers on a data byte that you specify. For use when the device under test data words are from 5 to 8 bits in length
 - a. Press the **Compare Type** softkey, and choose an equality qualifier. You can choose equal to, less than, or greater than a specific data value.
 - b. Use the **Value** softkey to choose the data value for your trigger comparison. This works in conjunction with the **Compare Type** softkey. The range of the Value is 0x00 to 0xff.

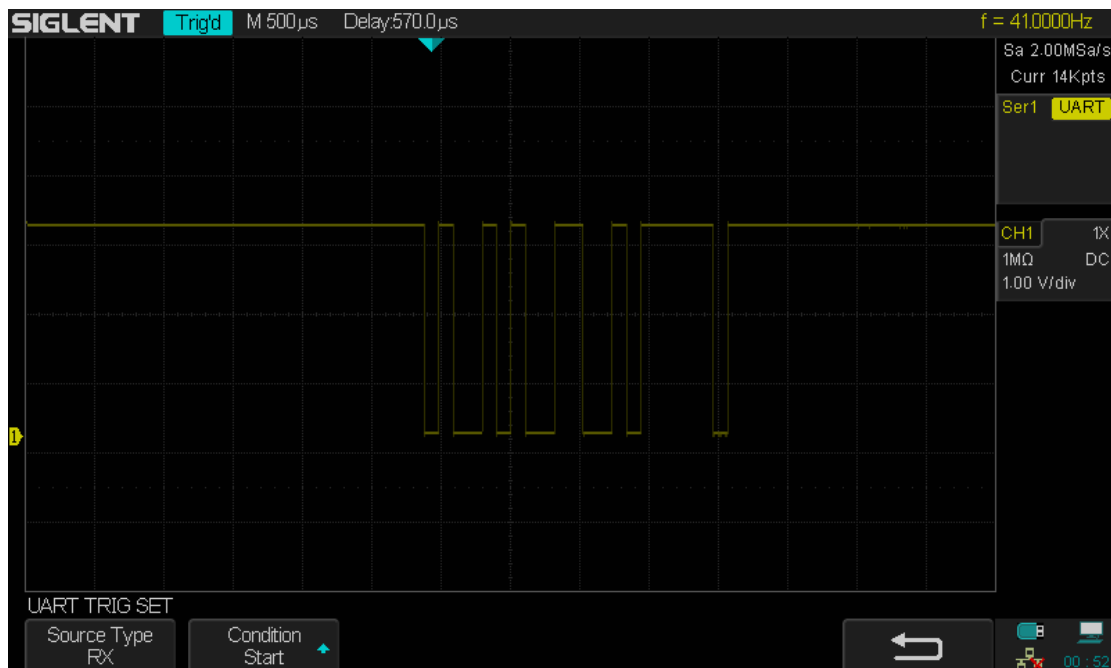

Figure 50 UART Trigger

UART/RS232 Serial Decode

To set up UART/RS232 serial decode:

1. Press **Decode** button on the front panel to display the DECODE function menu.



Figure 51 UART/RE232 DECODE Function Menu

2. Press the **Display** softkey and choose On to display the decode line on the display.
3. Press the **List** softkey to enter the LIST function menu.
4. Press the **Display** softkey and choose On to display the decode list on the display.
5. Press the **Scroll** softkey and the **Lines** softkey to set the position of the cursor and the line number of the list with the **Universal Knob**. The range of the **Lines** is 1 to 7.

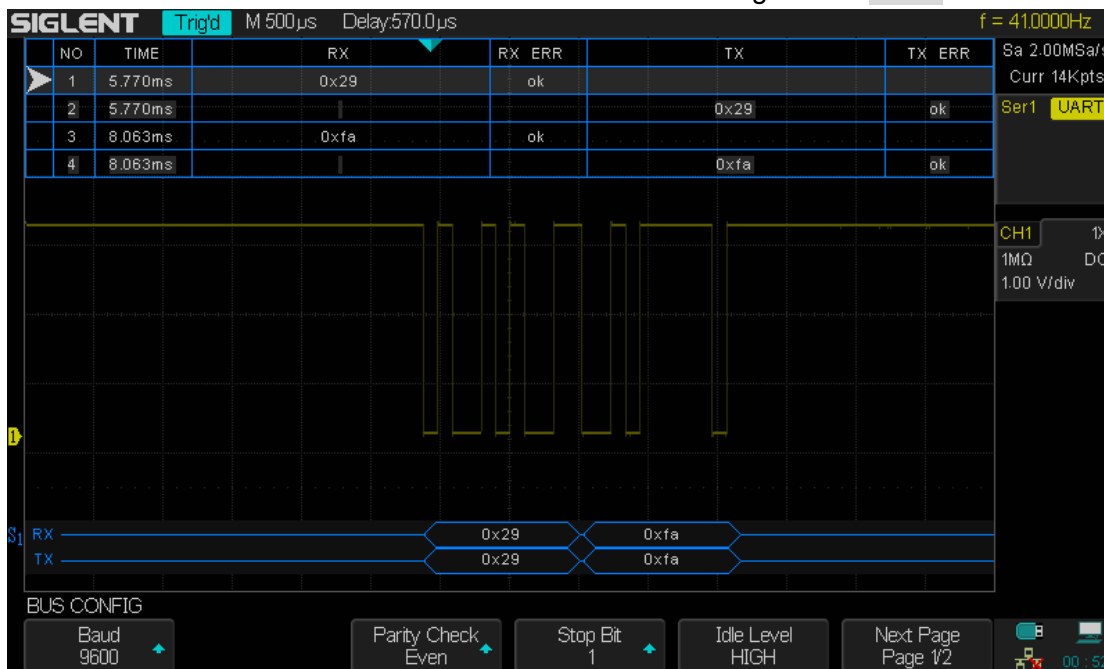

Figure 52 UART Decode

Interpreting UART/RS232 Decode

- Angled waveforms show an active bus (inside a packet/frame).
- Mid-level blue lines show an idle bus.
- Mid-level red lines show that the idle level is wrong.
- The decoded data is displayed in white.
- Decoded text is truncated at the end of the associated frame when there is insufficient space within frame boundaries.
- Blue vertical bars indicate you need to expand the horizontal scale (and run again) to see decode.
- When the horizontal scale setting does not permit the display of all available decoded data, red dots will appear in the decoded bus to mark the location of hidden data. Expand the horizontal scale to allow the data to display.
- An unknown (undefined) bus is shown in red.

Interpreting UART/RS232 Lister Data

In addition to the standard Time column, the UART/RS232 Lister contains these columns:

- Rx — Receive data.
- Tx — Transmit data.
- Rx err— Parity error or unknown error when receiving data.
- Tx err— Parity error or unknown error when transmit data.

To Save Reference Waveform

SDS1000X can save analog channel or math waveforms to one of four reference waveform locations in the oscilloscope. Then, a reference waveform can be displayed and compared against other waveforms. Four reference waveforms can be displayed at a time.

Use the appointed Variable knob and the Position knob which on the right side of the front panel to adjust the vertical scale and the vertical position of REF waveform.

The contents of this chapter:

- To Save REF Waveform to Internal Memory
- To Display REF Waveform
- To Adjust REF Waveform Display
- To Clear REF Waveform Display

To Save REF Waveform to Internal Memory

Do the following steps to save the REF waveform to internal memory:

1. Press the **REF** button on the front to enter the REF WAVE function menu. Note that when the time horizontal format is in X-Y mode, REF function cannot be enabled.
2. Press the **Source** softkey; then, turn the **Universal Knob** to select the source of reference channel. The source includes analog channel and math waveforms.
3. Press the **Location** softkey; then, turn the **Universal Knob** to select the position to save the REF waveform. The source includes analog channel and math waveforms.
4. Press the **Save** softkey to save the channel or math waveform to the appointed location. The vertical scale information and the vertical offset of the waveform will be saved at the same time. It will pop out the message "**Store Data Success**" when the waveform has been saved successfully.

Note: The REF waveforms are non-volatile. The REF waveform can still be saved after restarts or default operation.

To Display REF Waveform

To the following steps to display REF waveform:

1. Press the **REF** button on the front to enter the REF WAVE function menu.
2. Press the **Location** softkey; then, turn the **Universal Knob** to select the REF waveform that you want to display.
3. Press the **Display** softkey to select **On** to display the REF waveform on the screen. Only saved location can be displayed. SDS1000X can display all four reference waveforms at a time.

To Adjust REF Waveform Display

1. Please refer to the “To Display REF Waveform” above to display the desired reference waveform.
2. Press the **Scale** and **Position** softkey and turn the universal knob to adjust the vertical scale and position of the reference waveform. The vertical scale and position information display at the middle of the screen.

The initial values display at the middle of the screen is the setup that when the reference waveform been saved.

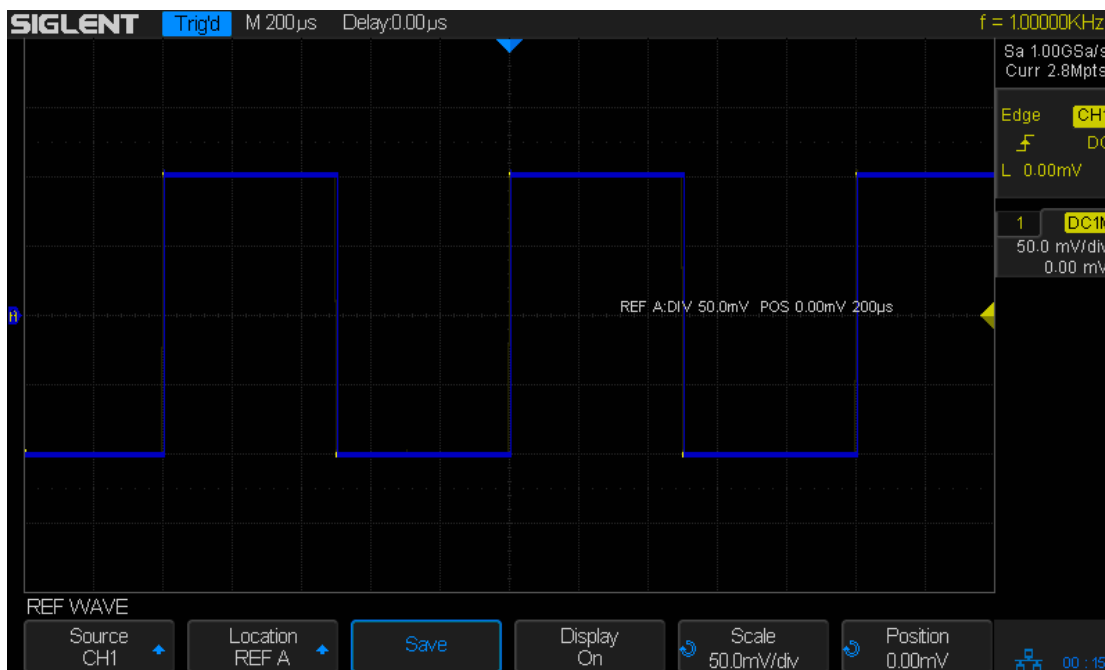

Figure 53 Reference Waveform

Note: The vertical Variable knob and the vertical Position knob are only works for the reference waveform and the math waveform. Please make a difference with the channel vertical system.

To Clear REF Waveform Display

SDS1000X does not have the “Clear” option under the REF WAVE function menu. To clear the appointed reference waveform, you can save a new reference waveform to the same location to cover it.

To Make Math Operation

SDS1000X supports many math operations between analog channels and reference waveforms, including addition (+), subtraction (-), multiplication (*), division (/), differential (d/dt), integral ($\int dt$), square root ($\sqrt{\quad}$). The resulting math waveform is displayed in white and labeled with "M". You can use cursors to measure it.

The contents of this chapter:

- ◆ Units for Math Waveforms
- ◆ Math Operators
- ◆ To Adjust the Math Waveform Scale and Offset

Note: if the analog channel or the math function is cut off (waveforms do not display on the screen completely), the resulting math will also be cut off.

Units for Math Waveforms

Use the channel function menu to set the unit of each channel to "V" or "A". SDS1000X math operation includes units as below:

Math Operation	Unit
Addition (+)or subtraction (-)	V, A
multiplication (*)	V ² , A ² or W (Volt-Amp)
division (/)	None or S
FFT	dBV _{rm} , V _{rm} , dBArms, Arms
differential (d/dt)	V/S or A/S (V/second or A/second)
integral ($\int dt$)	VS or AS (V/second or A/second)
square root ($\sqrt{\quad}$)	V ^{1/2} or A ^{1/2}

Math Operators

SDS1000X supports math count operation (Addition, subtraction, multiplication, division), FFT (Fourier transform) operation and math function operation (differential, integral, square root).

Addition or Subtraction

Math operators perform arithmetic operations add or subtract operation on any two analog input channels. When you select addition or subtraction, the **Source A** and **Source B** values are added or subtracted point by point, and the result is displayed.

1. Press the **Math** button on the front panel to enter the MATH function menu.
2. Press the **Source A** and **Source B** softkey respectively, and then turn the **Universal Knob** to select the source to do math operation. Analog channels (CH1 and CH2) and reference waveforms (REFA and REFB) can be used as Source A or source B.
3. Press the **Operation** softkey and then turn the universal to select **+** or **-** to make addition or subtraction operation. The resulting math waveform is displayed in white and labeled with "M".

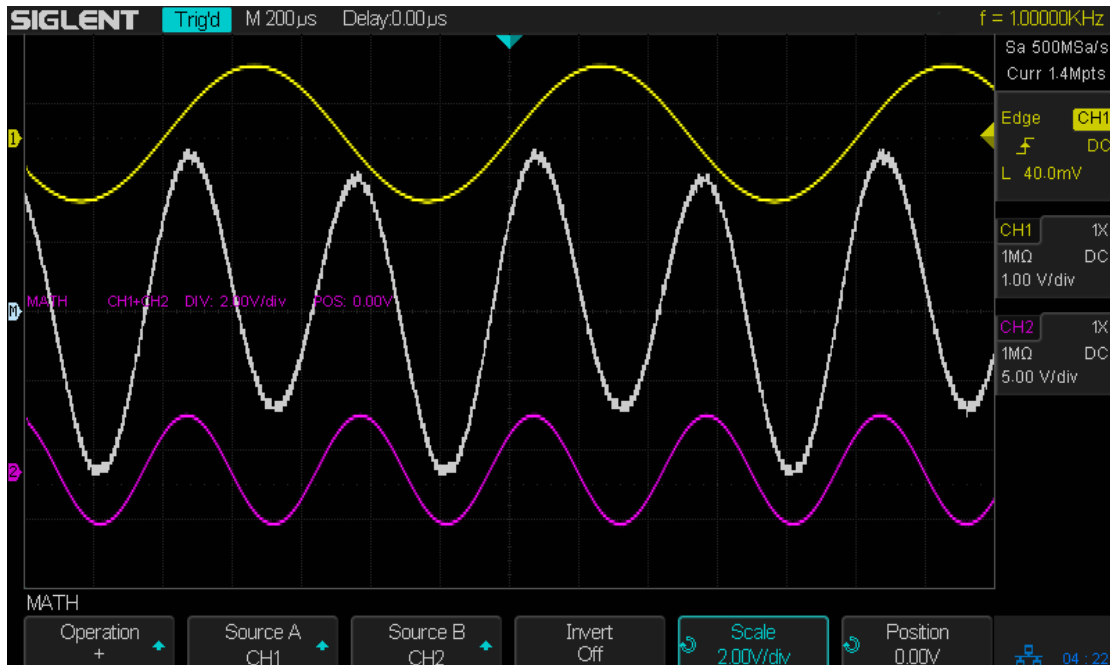

4. If you want to invert the math waveform, press the **Invert** button and set the option to **On** to invert the display of the math waveform.

Multiplication and Division

Math operators perform arithmetic operations multiplication or division operation on any two analog input channels. When you select multiplication or division, the **Source A** and **Source B** values are multiplied or divided point by point and the result is displayed.

1. Press the **Math** button on the front panel to enter the MATH function menu.
2. Press the **Source A** and **Source B** softkey respectively, and then turn the **Universal Knob** to select the source to do math operation. Analog channels (CH1 and CH2) and reference waveforms (REFA, REFB) can be used as Source A or source B.
3. Press the **Operation** softkey and then turn the universal to select * or / to make multiplication or division operation. The resulting math waveform is displayed in white and labeled with "M".

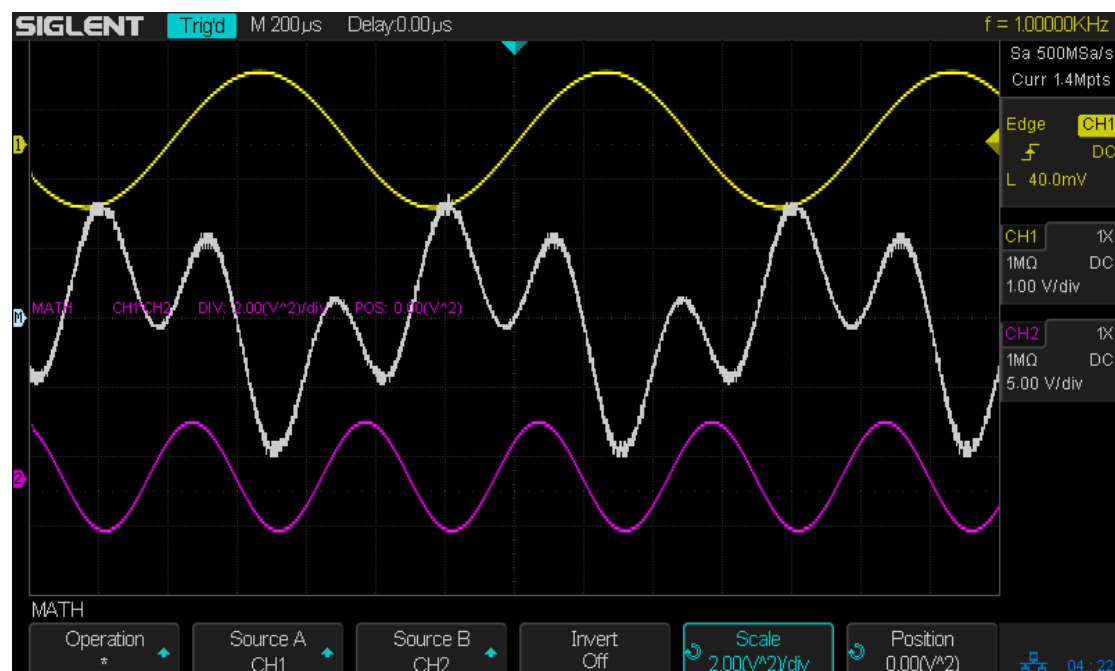

4. If you want to invert the math waveform, press the **Invert** button and set the option to **On** to invert the display of the math waveform.

FFT Operation

FFT is used to compute the fast Fourier transform using analog input channels or reference waveforms. FFT takes the digitized time record of the specified source and transforms it to the frequency domain. When the FFT function is selected, the FFT spectrum is plotted on the oscilloscope display as magnitude in dBV versus frequency. The readout for the horizontal axis changes from time to frequency (Hertz) and the vertical readout changes from volts to dB.

FFT operation can facilitate the following works:

- ◆ Measure harmonic components and distortion in the system
- ◆ Measure the characteristics of the noise in DC power
- ◆ Analyze vibration

To display a FFT waveform:

1. Press the **Math** button on the front panel to open the MATH function menu.
2. Press the **Operation** softkey and then turn the **Universal Knob** to select **FFT**. The resulting math waveform is displayed in white and labeled with "M".
3. Press the **Source** softkey, and then turn the **Universal Knob** to select the source to do FFT operation. Analog channels (CH1 and CH2) and reference waveforms (REFA, REFB) can be used as the source.
4. Press the **Window** softkey, and then turn the **Universal Knob** to select an appropriate window.

Spectral leakage can be considerably decreased when a window function is used. SDS1000X provides four kinds of FFT window functions which have different characteristics and are applicable to measure different waveforms. You need to select the window function according to different waveforms and their characteristics. Please read the table below carefully to make a appropriate option according to the input signal.

Window	Characteristics	Measurement
Rectangle	The best frequency resolution; the poorest amplitude resolution; similar to the situation when no window is multiplied.	Transient or short pulse, the signal levels before and after the multiplication are the basically the same; Sine waveform with the same amplitude and rather similar frequencies; Wide band random noise with relatively slowly changing waveform spectrum.
Hanning	Better frequency resolution; poorer amplitude resolution.	Sine, periodic and narrow band random noise.
Hamming	A litter bit better frequency resolution than Hanning.	Transient or short pulse, the signal levels before and after the multiplication are rather different.
Blackman	The best amplitude resolution; the poorest frequency resolution.	Single frequency signal, search for higher order harmonics.

5. Press the **FFT Zoom** softkey, and then turn the **Universal Knob** or turn the horizontal scale knob to select the desired magnifying multiple (1X, 2X, 5X, 10X). Set the **FFT Zoom** to an appropriate magnifying multiple to observe more details of the FFT waveform.
6. Press the **Scale** softkey to select the unit of vertical axis. The unit of the vertical axis can be dB or Vrms which use logarithmic mode and linear mode to display vertical amplitude respectively. If you need to display the FFT frequency spectrum in a relatively larger dynamic range, dBVrms is recommended.
7. Press the **Display** softkey to select **Split** or **Full Screen** display mode.
 - **Split:** the source channel and the FFT operation results are displayed separately. The time domain and frequency domain signals are displayed clearly

- **Full Screen:** the source channel and the FFT operation results are displayed in the same window to view the frequency spectrum more clearly and to perform more precise measurement.

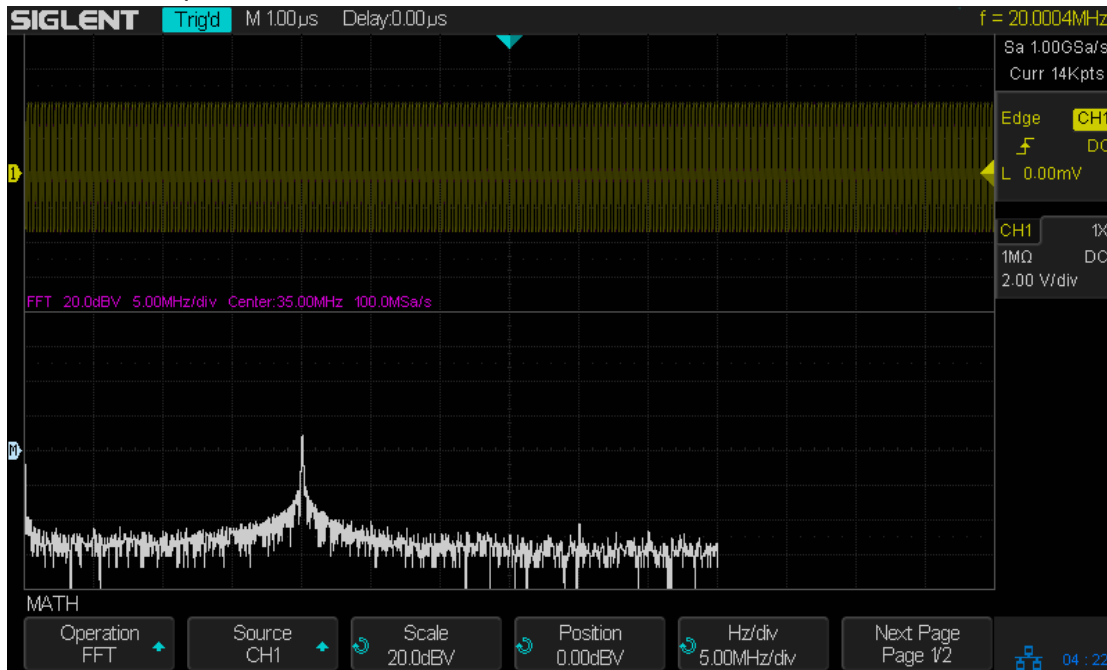

Figure 54 FFT Waveform In Split Mode

Note:

- Signals with DC components or deviation would cause error or deviation of the FFT waveform components. To reduce the DC components, set the Channel **Coupling** to **AC**.
- To reduce the random noise and aliasing frequency components of repetitive or single pulse, set the **Acquisition** of the oscilloscope to **Average**.

To measure FFT waveform:

To make cursor measurements, press the **Cursors** button, and then press the **Mode** softkey to select **On** to turn the cursors, Use the X1 and X2 cursors to measure frequency values and the difference between two frequency values (ΔX). Use the Y1 and Y2 cursors to measure amplitude in dB and difference in amplitude (ΔY).

You can find the frequency value at the first occurrence of the waveform maximum by using the X at Max Y measurement.

Note: please refer to the cursors chapter to obtain the method of using cursors.

Math Function Operation

SDS1000X supports math function operation including differential (d/dt), integral ($\int dt$) and square root ($\sqrt{\quad}$).

Differentiate

d/dt (differentiate) calculates the discrete time derivative of the selected source.

$$di = \frac{y(i + \Delta t) - y(i - \Delta t)}{2 \Delta t}$$

Where:

- d = differential waveform.
- y = channel 1, 2, 3, or 4 data points.
- i = data point index
- Δt = point- to- point time difference.

The **dx** option under d/dt math function operation menu shows the point- to- point time difference, and it ranges from 0.02div to 0.40div. “div” indicates the number of the pixel points that each division has. SDS1000X has 50 pixel points per division. Take 0.2div as an example: $0.2 * 50 = 10$. It means to calculate the ten point’s discrete time derivative of the selected source, and the Δt is the ten point’s point- to- point time difference.

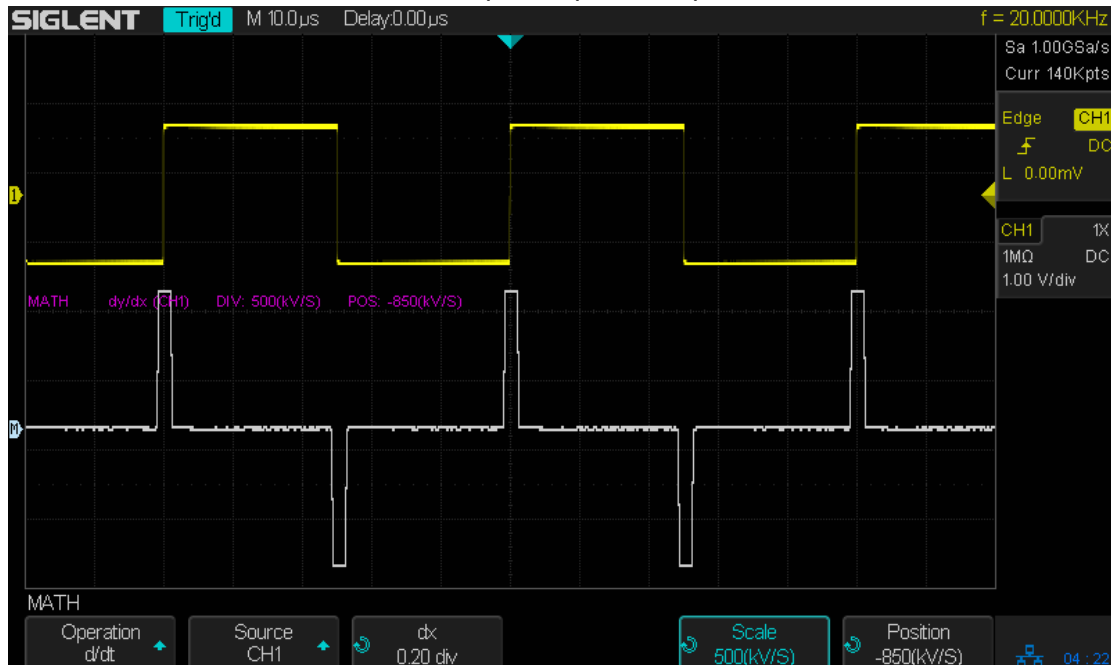

Figure 55 Differential Function Operation

You can use differentiate to measure the instantaneous slope of a waveform. For example, the slew rate of an operational amplifier may be measured using the differentiate function

Note: Because differentiation is very sensitive to noise, it is helpful to set acquisition mode to **Average**.

Integrate

dt (integrate) calculates the integral of the selected source. You can use integrate to calculate the energy of a pulse in volt- seconds or measure the area under a waveform. dt plots the integral of the source using the "Trapezoidal Rule". The equation is:

$$I_n = c_0 + \Delta t \sum_{i=0}^n y_i$$

Where:

- I = integrated waveform;
- Δt = point- to- point time difference;
- y = channel 1, 2, or REFA,REFB
- c_0 = arbitrary constant;
- i = data point index;

The integrate operator provides an **Offset** softkey that lets you enter a DC offset correction factor for the input signal. Small DC offset in the integrate function input (or even small oscilloscope calibration errors) can cause the integrate function output to "ramp" up or down. This DC offset correction lets you level the integrate waveform.

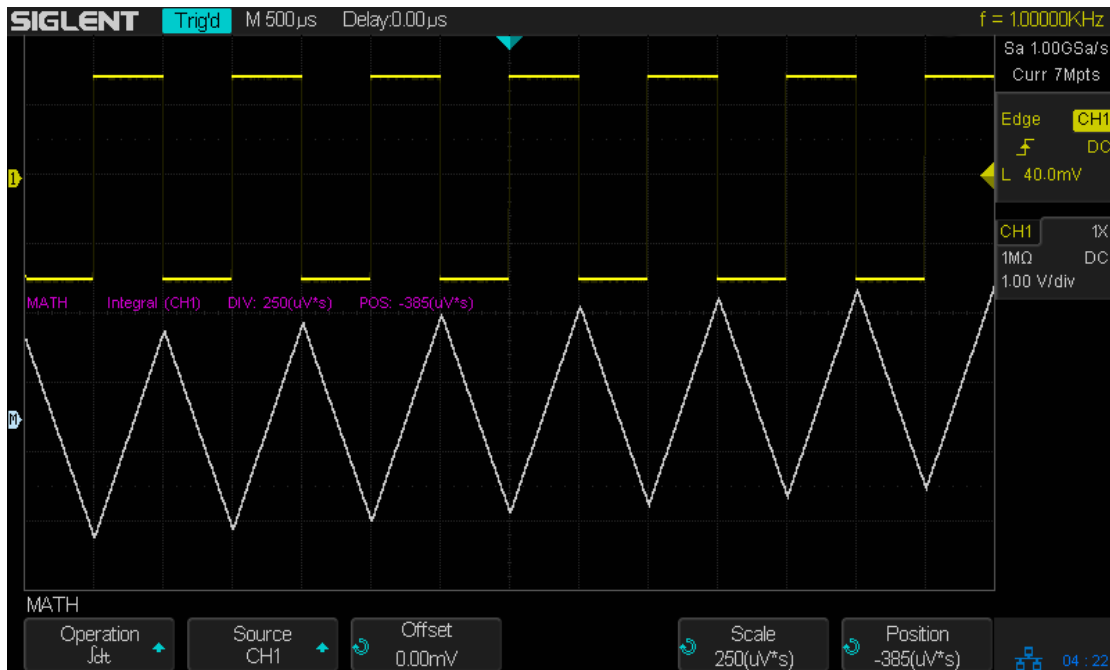

Figure 56 Integral without Offset

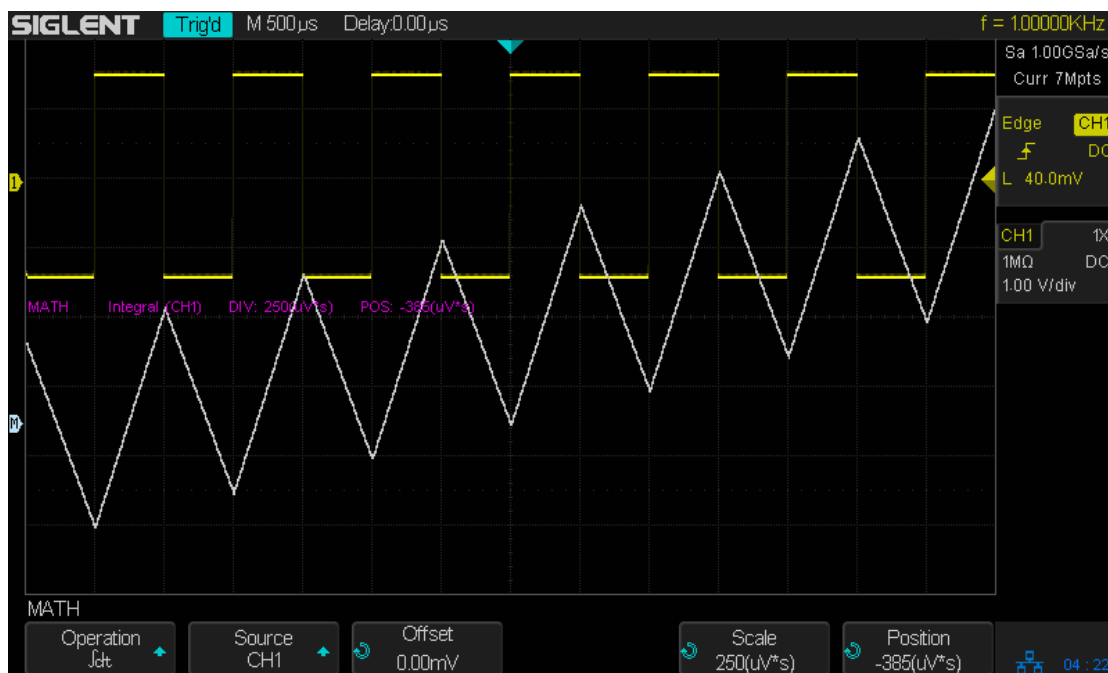

Figure 57 Integral with Offset

Square Root

Square root ($\sqrt{\quad}$) calculates the square root of the selected source.

Where the transform is undefined for a particular input, holes (zero values) appear in the function output.

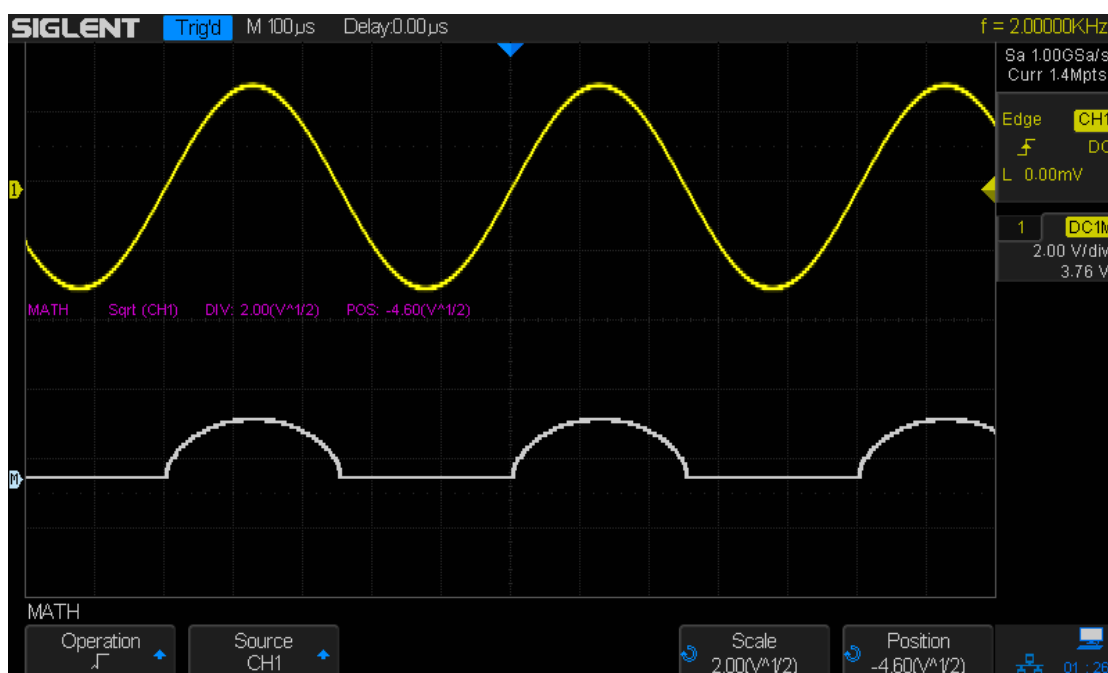

Figure 58 Square Root

To Make Cursors Measurements

Cursors are horizontal and vertical markers that indicate X- axis values and Y- axis values on a selected waveform source. You can use cursors to make custom voltage, time measurements on oscilloscope signals.

X Cursors

X cursors are vertical dashed lines that adjust horizontally and can be used to measure time (when the source is FFT waveform, X cursors measure frequency)

X1 cursor is the left (default position) vertical dotted line; it can be moved to any place of the screen.

X2 cursor is the right (default position) vertical dotted line; it can be moved to any place of the screen.

Use the **Universal Knob** to set the **X1** and **X2** cursor values and the values are displayed in the cursors box in the upper-left corner of the screen along with the difference between X1 and X2 (ΔT) and $1/\Delta T$.

When set cursor type to **X1-X2**, use **Universal Knob** will move the X1 and X2 cursors together. The value under the menu option is the difference between the X1 and X2 cursors.

Y Cursors

Y cursors are horizontal dotted lines that adjust vertically and can be used to measure voltage (V) or current (A). When the cursors source is the math function, the unit will match the math function.

Y1 cursor is the top (default position) horizontal dotted line; it can be moved to any vertical place of the screen.

Y2 cursor is the down (default position) horizontal dotted line; it can be moved to any vertical place of the screen.

Use the **Universal Knob** to set the Y1 and Y2 cursor values and the values are displayed in the cursors box in the top left corner of the screen along with the difference between Y1 and Y2 (ΔY).

When set cursor type to **Y1-Y2**, use **Universal Knob** will move the Y1 and Y2 cursors together. The value under the menu option is the difference between the Y1 and Y2 cursors.

To Make Cursor Measurements

1. Press the **Cursors** button on the front panel to enter the CURSOR function menu.
2. Press the **Mode** softkey and set the option to **On**.
3. Press the **Source** softkey, and then use the **Universal Knob** to select the desired source. Only analog channels (CH1, CH2), math waveforms and reference waveforms (REFA, REFB) that are displayed are available for cursors.
4. To make cursor measurements:
 - To measure the horizontal time, use the **Universal Knob** to move the X1 and X2 cursors to desired place. If necessary, set the cursor type to **X1-X2**, move X1 and X2 cursors together.
 - To measure vertical voltage or current, use the **Universal Knob** to move the Y1 and Y2 cursors to desired place. If necessary, set the cursor type to "Y1-Y2", move Y1 and Y2 cursors together.
 - To adjust the transparenence of the cursors message box, press the **Display/Persist** button and go to the second page, press the **Transparenence** (20% to 80%) softkey and then turn the **Universal Knob** to adjust the transparenence to the desired value.

Cursor examples:

1. Use cursors to measure pulse width:

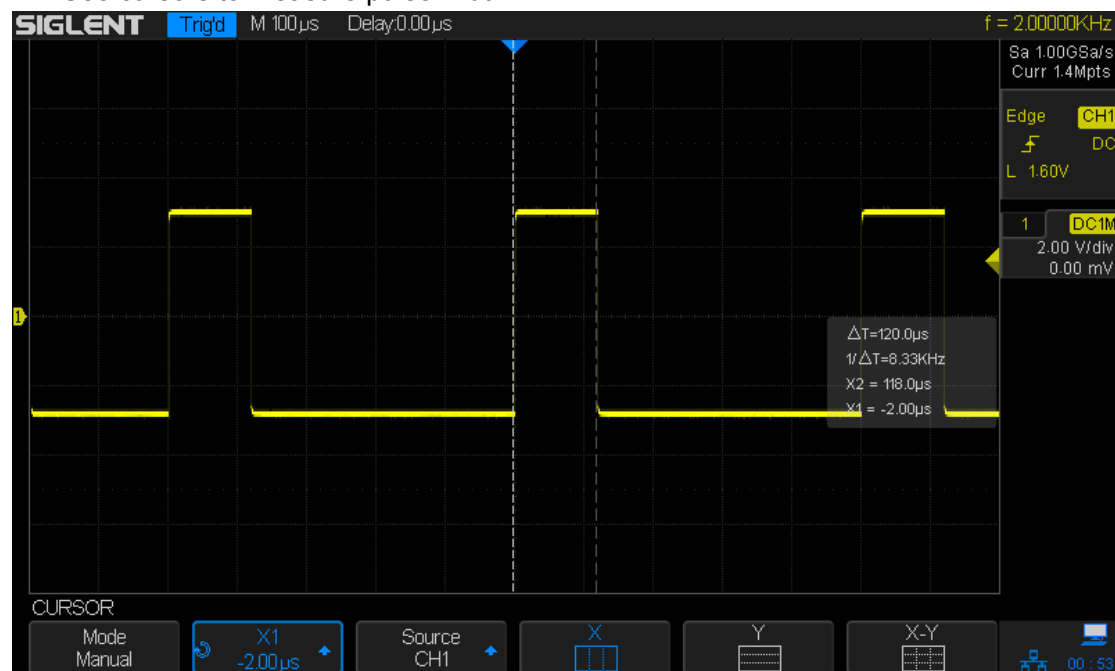

Figure 59 Measure Pulse Width

To Make Measurements

SDS1000X provides measurements of 36 waveform parameters and the statistics. It contains voltage, time and delay parameters.

Voltage and time parameters are under Type option. The results of the last five selected measurements are displayed at the bottom of screen and above the menu. Delay parameters are under the **All Measure** submenu. Set the Delay option to On to display all the delay parameters.

The contents of this chapter:

- ◆ Type of measurements
 - Voltage Measurements
 - Time Measurements
 - Delay Measurements
- ◆ To make automatic measurement
- ◆ To clear measurements
- ◆ To make all parameters measurement

Type of Measurement

Voltage Measurements

Voltage measurements include 15 kinds of voltage parameter measurements.

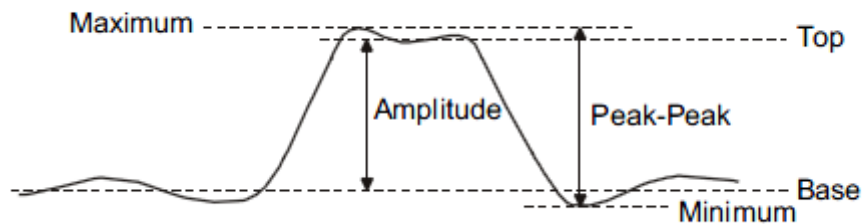

Figure 60 Voltage Measurements

1. **Vpp**: The peak- to- peak value is the difference between Maximum and Minimum values.
2. **Vmax**: Maximum is the highest value in the waveform display.
3. **Vmin**: Minimum is the lowest value in the waveform display.
4. **Vamp**: The Amplitude of a waveform is the difference between its Top and Base values.
5. **Vtop**: The Top of a waveform is the mode (most common value) of the upper part of the waveform, or if the mode is not well defined, the top is the same as Maximum.
6. **Vbase**: The Base of a waveform is the mode (most common value) of the lower part of the waveform, or if the mode is not well defined, the base is the same as Minimum. The Y cursor shows the value being measured.
7. **Vmea**: The arithmetic mean over the first cycle of the waveform.
8. **Mean**: The arithmetic over the entire waveform.
9. **Stddev**: Standard deviation of all data values
10. **Vstd**: Standard deviation of all data values in the first cycle
11. **Vrms**: The true Root Mean Square voltage over the entire waveform.
12. **Crms**: The true Root Mean Square voltage of the first cycle in the waveform.
13. **Overshoot**: Overshoot is distortion that follows a major edge transition expressed as a percentage of Amplitude. ROV means rising edge overshoot and FOV means falling edge overshoot.

$$\text{Rising edge overshoot} = \frac{\text{local Maximum} - \text{D Top}}{\text{Amplitude}} \times 100$$

$$\text{Falling edge overshoot} = \frac{\text{Base} - \text{D local Minimum}}{\text{Amplitude}} \times 100$$

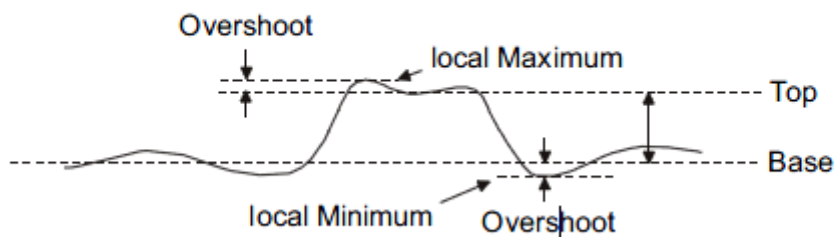

Figure 61 Overshoot

14. Preshoot: Preshoot is distortion that precedes a major edge transition expressed as a percentage of Amplitude. The X cursors show which edge is being measured (edge closest to the trigger reference point).

$$\text{Rising edge preshoot} = \frac{\text{local Minimum} - \text{D Top}}{\text{Amplitude}} \times 100$$

$$\text{Falling edge preshoot} = \frac{\text{Base} - \text{D local Minimum}}{\text{Amplitude}} \times 100$$

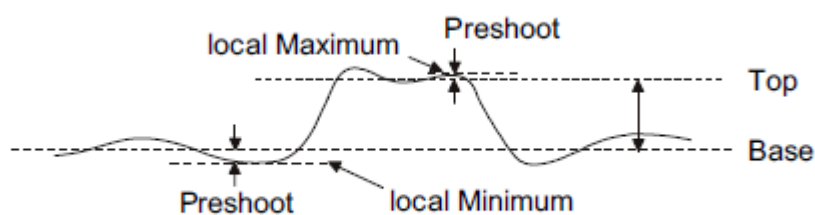

Figure 62 Preshoot

15. Level@X: the voltage value between the trigger point and the vertical position of the channel

Time Measurements

Time measurements include 9 kinds of time parameter measurements.

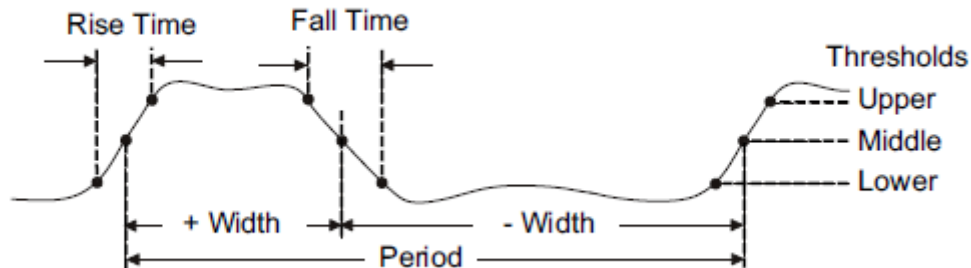

Figure 63 Time Measurements

1. **Period:** defined as the time between the middle threshold points of two consecutive, like-polarity edges.
2. **Frequency:** defined as the reciprocal of period.
3. **+ Width:** the time difference between the 50% threshold of a rising edge to the 50% threshold of the next falling edge of the pulse.
4. **- Width:** the time difference between the 50% threshold of a falling edge to the 50% threshold of the next rising edge of the pulse.
5. **Rise Time:** the time for the signal amplitude to rise from 10% to 90%.
6. **Fall Time:** the time for the signal amplitude to fall from 90% to 10%.
7. **BWid:** the duration of a burst over the entire waveform.
8. **+ Duty:** the ratio of the positive pulse width to the period.
9. **- Duty:** the ratio of the negative pulse width to the period.
10. **Delay:** Time from the trigger to the first transition at the 50% crossing.
11. **Time@Level:** Time from trigger of each transition at a specific level and slope.

Delay Measurements

Delay measurements measure the time different between arbitrary two channels, including 9 kinds of delay measurements.

1. **Phase:** The phase difference between two channels.
2. **FRR:** The time between the first rising edge of source 1 and the first rising edge of source 2 of 50 voltage level.
3. **FRF:** The time between the first rising edge of source 1 and the first falling edge of source 2 of 50 voltage level.
4. **FFR:** The time between the first falling edge of source 1 and the first rising edge of source 2 of 50 voltage level.
5. **FFF:** The time between the first falling edge of source 1 and the first falling edge of source 2 of 50 voltage level.
6. **LRR:** The time between the last rising edge of source 1 and the last rising edge of source 2 of 50 voltage level. **LRR:** The time between the last rising edge of source 1 and the last falling edge of source 2 of 50 voltage level.
7. **LRF:** The time between the last rising edge of source 1 and the last falling edge of source 2 of 50 voltage level.
8. **LFR:** The time between the last falling edge of source 1 and the last rising edge of source 2 of 50 voltage level.
9. **LFF:** The time between the last falling edge of source 1 and the last falling edge of source 2 of 50 voltage level.

To Make Automatic Measurement

Perform the steps below and select voltage or time parameters to make automatic measurement.

1. Press the **Measure** button on the front panel to enter the MEASURE function menu. At the same, the frequency and period are enabled with the current trigger channel, the statistics also was enabled.
2. Press the **Source** softkey, and then use the **Universal Knob** to select the desired channel. Only analog channels (CH1 and CH2) that are displayed are available for measurements.
3. To select and display measurement parameters. Press the **Type** softkey, and then turn the **Universal Knob** to select the desired measurement parameter.
4. Press the **Universal Knob** to add the measurement parameter, the parameters and value will be shown above the menu, and the statistics status will update.
5. To turn off the statistic function, press the **Statistics** softkey to select **Off**.

The measurement display area can display 5 measurement parameters at most, and the measurements will arrange according to the selecting order. If add a sixth measurement parameter, it will delete the first measurement.



Figure 64 Select the Measurement Parameter

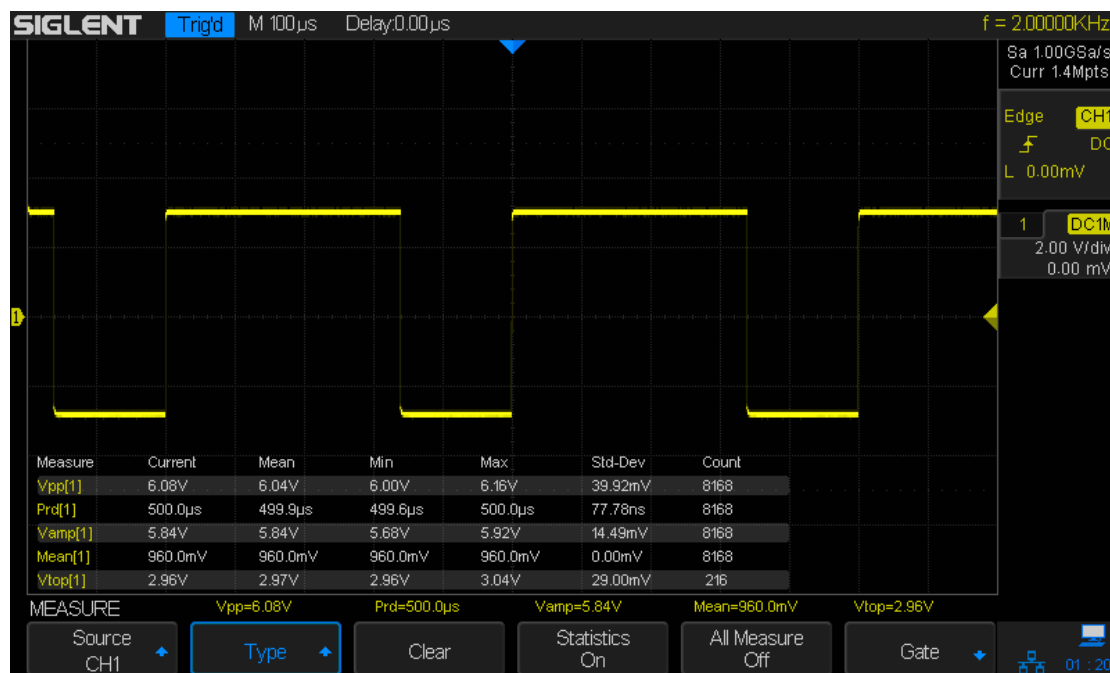

Figure 65 Added the Measurement

Note: if the parameter does not match the measure condition, it will display as "****".

To Clear Measurement Parameters

Press the **Clear** softkey to clear all the measurement parameters that are displaying on the screen.

To Make All Measurement

All measurement could measure all the voltage, time and delay parameters of the current measurement source and display the results on the screen.

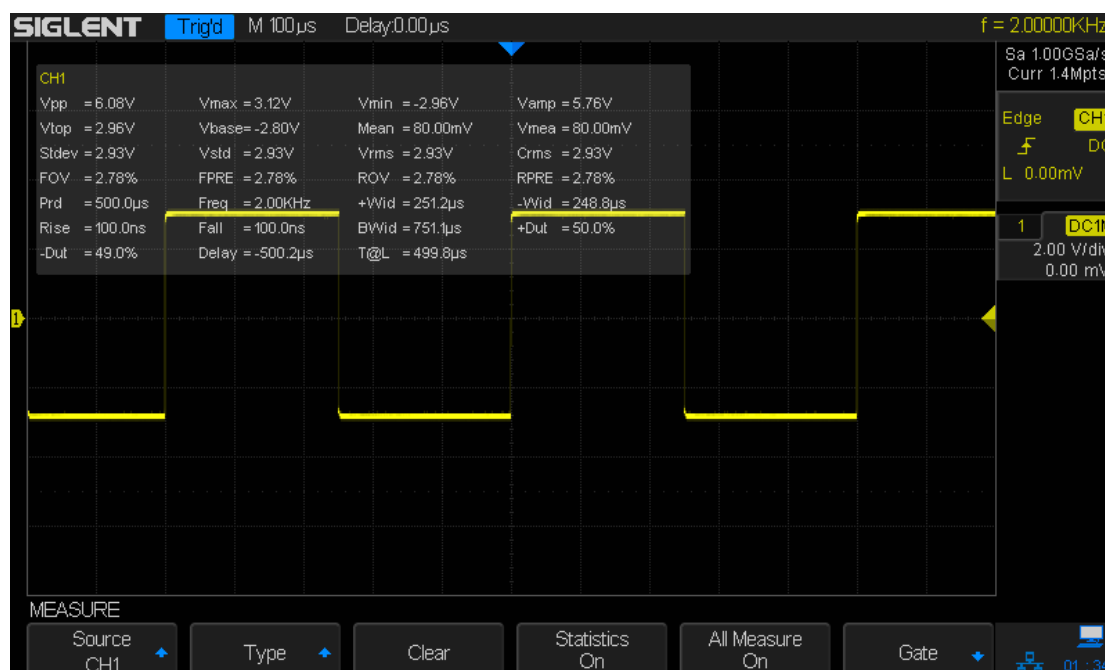

Figure 66 All Parameters Measurement

Do the following steps to make all parameters measurement.

1. Press the **Measure** button on the front panel to enter the MEASURE function menu.
2. Press the **All Measure** softkey to select **On**.
3. Press the **Source** softkey to select the measure source (CH1, CH2, MATH, REFA, REFB).

Display Setting

You can set the display type, color, persistence, grid type, waveform intensity, grid brightness and transparence.

The contents of this chapter:

- ◆ To Set Display Type
- ◆ To Set Color Display
- ◆ To Set and Clear Persistence
- ◆ To Clear the Display
- ◆ To Select Grid Type
- ◆ To Adjust the Waveform Intensity
- ◆ To Adjust the Grid Brightness
- ◆ The Adjust the Transparence

To Set Display Type

Press the **Display** button on the front panel, and then press the **Type** softkey to select **Vectors** or **Dots** display type.

- **Vectors:** the sample points are connected by lines and displayed. Normally, this mode can provide the most vivid waveform to view the steep edge of the waveform (such as square waveform).
- **Dots:** display the sample points directly. You can directly view each sample point and use the cursor to measure the X and Y values of the sample point.

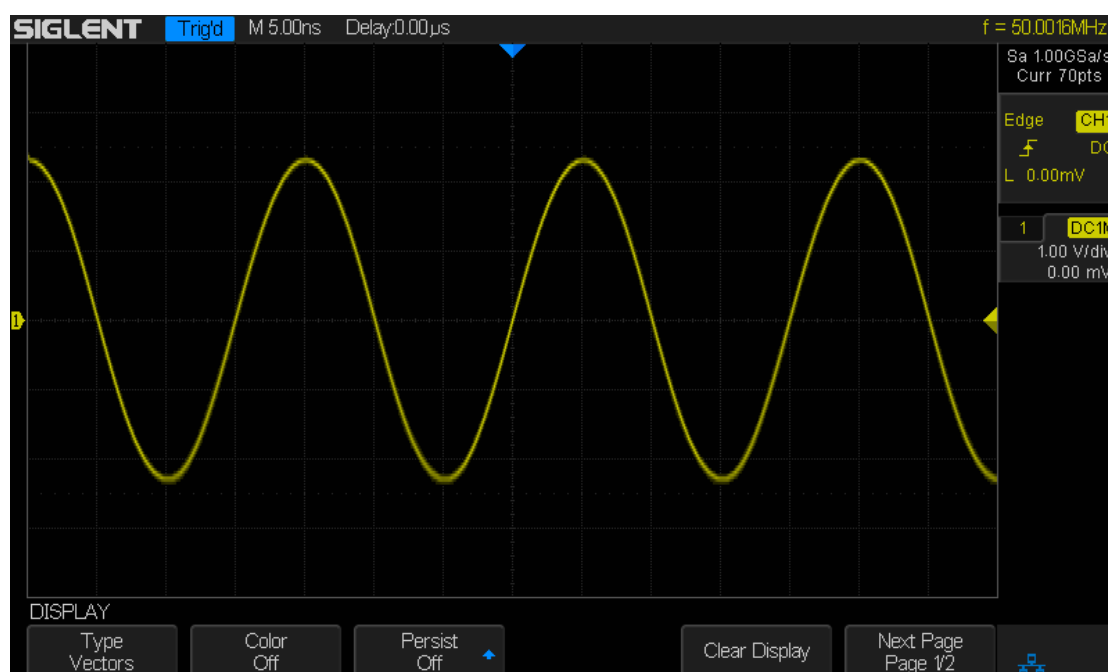

Figure 67 Vectors Display



Figure 68 Dots Display

To Set Color Display

Color temperature adopts the change of waveforms' color to reflect the change of the waveforms' appearing probability. The greater the probability that the waveform appears, the warmer the color is; the smaller the waveform appears, the colder the color is. The picture below shows the change of color from cold to warm. Press the Display button on the front panel, and then press the **Color** softkey and set the option to **On** to turn on the color temperature function. You can compare the waveform's color with the picture below to just the probability that the waveform appears.

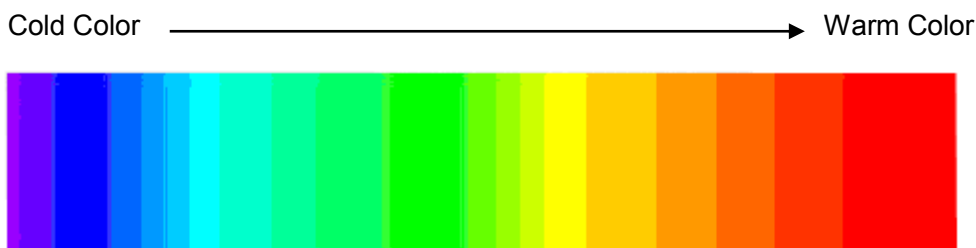

Figure 69 Color Temperature

To Set and Clear Persistence

With persistence, the oscilloscope updates the display with new acquisitions, but does not immediately erase the results of previous acquisitions. All previous acquisitions are displayed with reduced intensity. New acquisitions are shown in their normal color with normal intensity.

Do the following steps to set and clear persistence:

1. Press the **Display/Persist** button on the front panel to enter the DISPLAY function menu.
2. Press the **Persist** softkey; then turn the **Universal Knob** to select the desired option.
 - **Off** —turn off persistence.
 - Variable persistence time (1 second, 5 seconds, 10 seconds, 30 seconds) — select different persistence time, the results of previous acquisitions are erased after a certain amount of time
 - **Infinite** —select "Infinite" Results of previous acquisitions are never erased. Use infinite persistence to measure noise and jitter, to see the worst- case extremes of varying waveforms, to look for timing violations, or to capture events that occur infrequently.



Figure 70 Persist Set to Infinite

3. When the **Persist** is **On**, to erase the results of previous acquisitions from the display, press the **Clear Persist** softkey. The oscilloscope will start to accumulate acquisitions again.
4. To return to the normal display mode, turn off persist and the previous acquisitions will be clear at once.

To clear the display

Press the Display button on the front panel to enter the DISPLAY function menu; press the **Clear Display** softkey to clear all the waveforms displaying on the screen and acquire and display new waveforms.

To Select Grid Type

To select grid type

1. Press the **Display/Persist** button on the front panel to enter the DISPLAY function menu.
2. Press the **Next Page** softkey to go to the second page of the Display function menu.
3. Press the **Grid** softkey; and then turn the **Universal Knob** to select the desired grid type. Press the **Grid** softkey continually can also select the grid type.

There are 5 kinds of grid types that are available. Select the grid type according to your really demand.



Display 14X8 grid type



Display 2X2 grid type



Display without grid

To Adjust Waveform Intensity

Do the following steps to adjust waveform intensity:

1. Press the **Display/Persist** button on the front panel to enter the DISPLAY function menu.
2. Press the **Next Page** softkey to go to the second page of the Display function menu.
3. Press the **Intensity** softkey; and then turn the **Universal Knob** to select the desired value. The default value is 50%, and the range is from 0% to 100%.

Increasing the intensity lets you see the maximum amount of noise and infrequently occurring events. Reducing the intensity can expose more detail in complex signals as shown in the following figures.



Figure 71 Intensity Set to 100%



Figure 72 Intensity Set to 10%

Note: Waveform intensity adjustment affects analog channel waveforms only (not math waveforms, reference waveforms, digital waveforms, etc.).

To Adjust Grid Brightness

Do the following steps to adjust the grid brightness:

1. Press the **Display** button on the front panel to enter the DISPLAY function menu.
2. Press the **Next Page** softkey to go to the second page of the Display function menu.
3. Press the **Brightness** softkey; and then turn the **Universal Knob** to select the desired value. The default value is 40%, and the range is from 0% to 100%.

To Adjust Transparence

Transparence can be used to adjust the transparence of the message box of cursor, measure, Pass/Fail and all pop-up menus to an appropriate value to observe the date more conveniently.

Under Cursor or Measure or any other menu operation, if want to change the transparence of the message box, do the following steps:

1. Press the **Display** button on the front panel to enter the DISPLAY function menu.
2. Press the **Next Page** softkey to go to the second page of the Display function menu.
3. Press the **Transparence** softkey; and then turn the **Universal Knob** to select the desired value. The default value is 50%, and the range is from 0% to 100%.

Save and Recall

Oscilloscope setups, waveforms, pictures, and CSV files can be saved to internal oscilloscope memory or to a USB storage device. The saved setups, waveforms can be recalled later. SDS1000X provides an USB Host interface on the front panel to connect an USB device for external storage.

The contents of this chapter

- ◆ Save Type
- ◆ Internal Save and Recall
- ◆ External Save and Recall
- ◆ Disk Management

Save Type

SDS1000X supports setups, waveforms, pictures and CSV files storage. The default save type is setups.

1. Setups

It's the default storage type of SDS1000X. SDS1000X saves the settings of the oscilloscope in internal or external memory in "*.SET" format. At most 20 setting files (from No.1~No.20) can be stored in internal memory. The stored settings can be recalled.

2. Waveform

SDS1000X saves the waveform data in external memory in "*.DAV" format. The data of all the channels turned on can be saved in the same file. At recall, the data will be displayed on the screen directly.

3. Picture

SDS1000X saves the screen image in external memory in "*.bmp" format. You can specify the file name and saving directory under the same directory using the same file name. The recall of image is not supported.

4. CSV

SDS1000X saves the waveform data in external memory in "*.CSV" format. The stored files contain the waveform data of the displayed analog channels and the main setting information of the oscilloscope. The recall of CSV file is not supported.

Set the save type to **CSV**, and set the **Para Save** option to **On** or **Off** to turn on or of the parameters storage function.

Internal Save and Recall

Internal save and recall support Setups in **Save/Recall**. In the following part, the save and recall method and procedures are introduced.

➤ **Save the specified oscilloscope setting in internal memory.**

1. Connect the signal to the oscilloscope and obtain stable display.
2. Press **Save/Recall** button on the front panel to enter the SAVE/RECALL function menu.
3. Press the **Type** softkey and then turn the **Universal Knob** to select **Setups**; and then press the knob to confirm.
4. Press the **Save To** softkey to select **Internal** to save the current setup of the oscilloscope to the internal memory.
5. Press the **Setup** softkey button; and then turn the **Universal Knob** to select the location to save. The internal memory can save as many as 20 setup files, from No.1~No.20.
6. Press the **Save** softkey to save the current setup to the appointed location. After a few seconds, it will pop-out the message “**Store Data success!**”

➤ **Load the specified type of file in internal memory.**

If want to recall the setup after having finished the steps above, please do the following steps:

Press the **Setup** softkey, and then turn the **Universal Knob** to select the location that you want to recall, press the **Recall** softkey to recall the setup, and it will pop-out the message “**Read Data Success!**”

Note: if need to delete a setup file in the memory, please save a new setup to the same location to overwrite it.

External save and recall

Before using external storage and recall, make sure that the USB flash device is connected correctly. External storage supports all the types of files in save, but in recall, **Picture** and **CSV** are not supported.

➤ **Save the specified type of file in the external USB flash device.**

1. Press the **Save/Recall** button on the front panel to enter the SAVE/RECALL function menu.
2. Press the **Type** softkey to select **Waveforms** or **Setup**
3. Press the **Recall** softkey to enter the SAVE/RECALL file system.

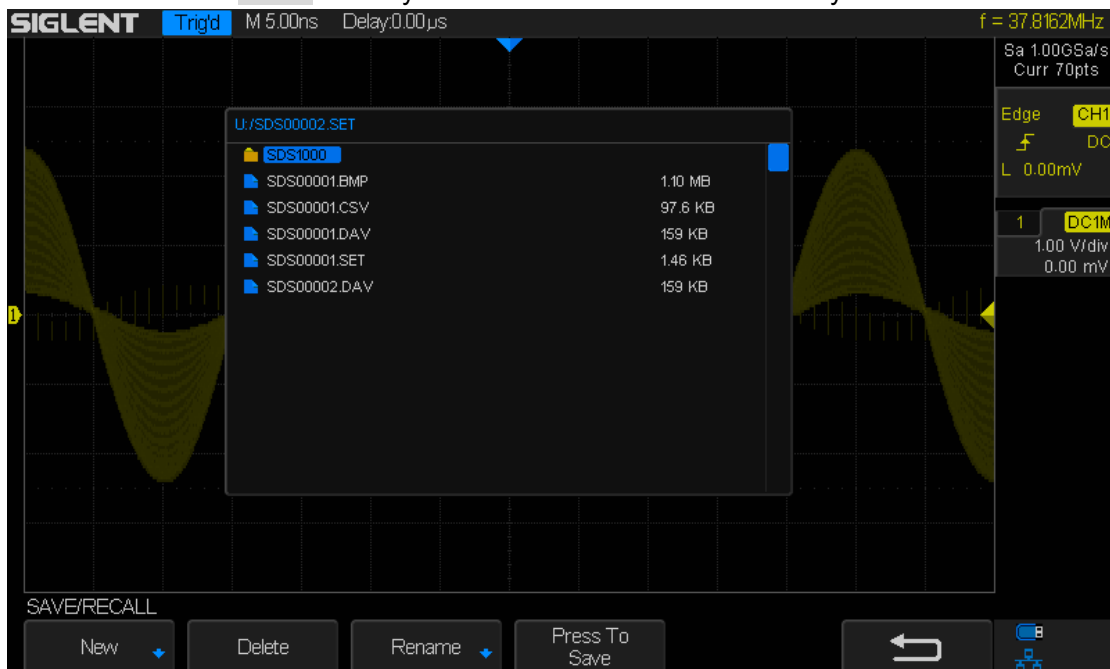

Figure 73 SAVE/RECALL File System

4. Use the **Universal Knob** to select the desired location. File can be stored under the root directory or in a certain folder under the root directory of the USB storage device.

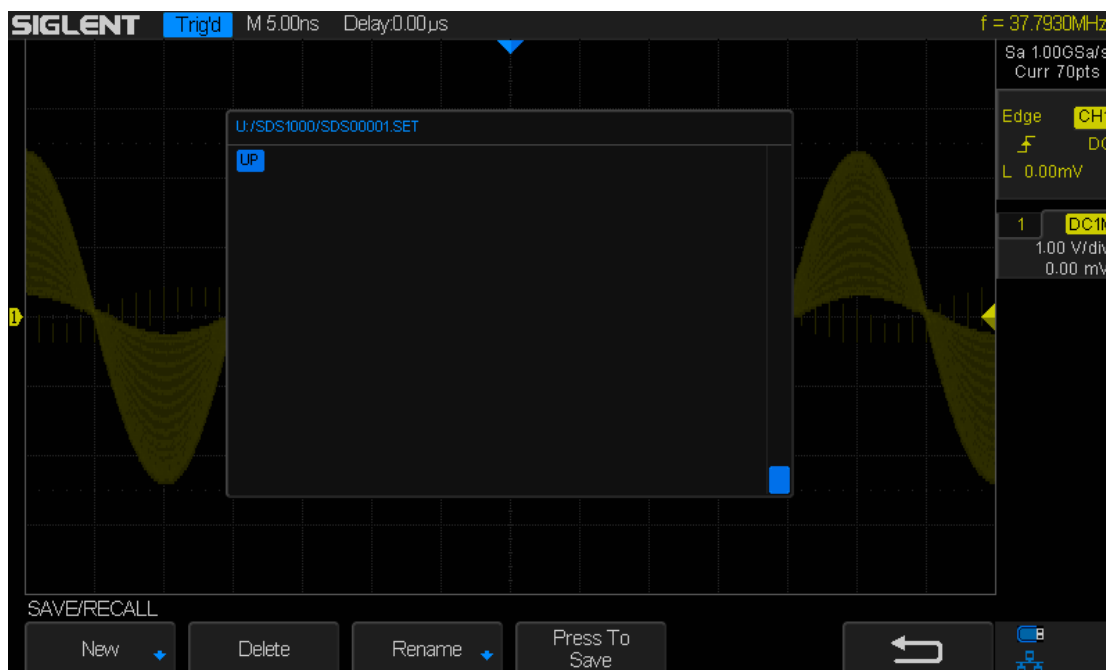

Figure 74 Select Save Location

- After the save position is selected, press the **New** softkey to turn on the interface as shown in the figure below. Refer to the descriptions in **“To Create a new file or fold”** to create a new file name.

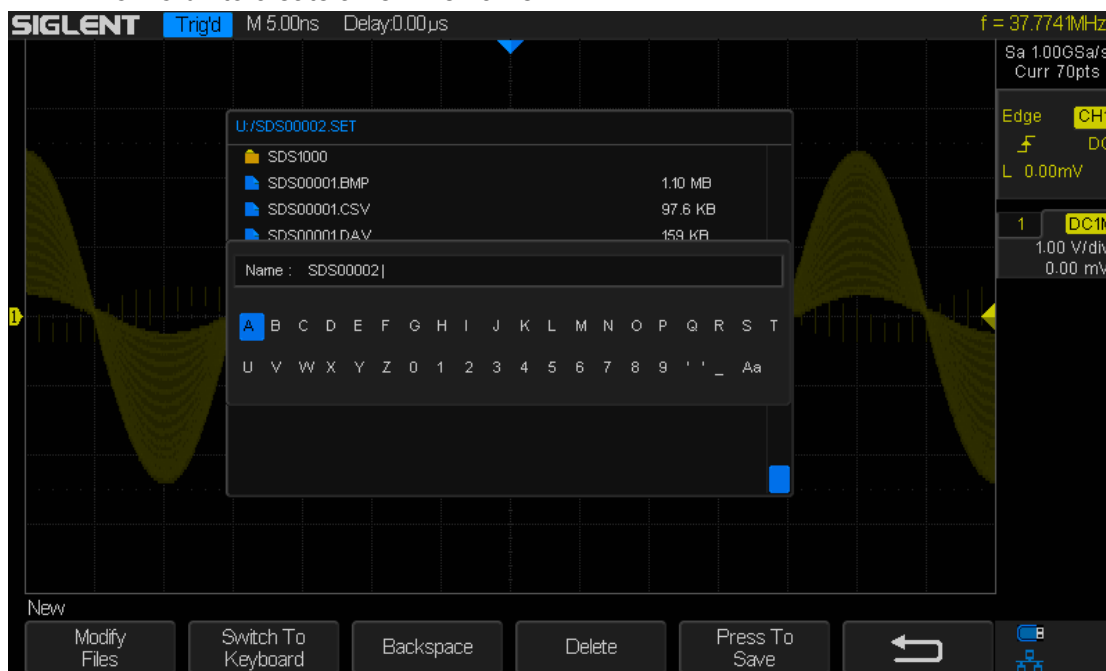

Figure 75 File Name Dialogue

- Press the Enter softkey to save the current waveform to the external USB storage device,

- **Load the specified type of file in the external USB storage device.**
 7. Press the **Save/Recall** button on the front panel to enter the SAVE/RECALL function menu.
 8. Press the **Type** softkey to select **Waveforms** or **Setup**
 9. Press the **Recall** softkey to enter the SAVE/RECALL file system.
 10. Turn the **Universal Knob** to select the file to be recalled, press the **Load** softkey to recall the waveform or setup.

Disk Management

Disk management aim at the save and recall operations after the oscilloscope is connected with a USB storage device. Before using external disk, make sure that the USB storage device is connected correctly.

Execute the following operations through the disk management menu:

- ◆ To Create a New File or Folder
- ◆ To Delete a File or Folder
- ◆ To Rename a File or Folder

To Create a New File or Folder

This operation is only valid in external storage. SDS1000X supports English input method. The file name or folder name can contain letters, numbers, underscores and spaces. Let's use an example to introduce how to create a file or folder.

Example: create a file or folder named "SDS2013ab"

1. Press the **Save/Recall** button on the front to enter the SAVE/RECALL function menu.
2. Press the **Type** softkey, and then turn the **Universal Knob** to select one of the type (if select **Setups**, please set the **Save To** option to **External**).
3. Press the **Save** or **Recall** softkey to enter the SAVE/RECAL file system.
Press the **Modify** softkey to select **File** or **Folder**, and then press the **New** softkey to open the interface shown as the picture below. It divides into two parts: name input area and keyboard area. The default is name input area. As the picture shows below, "aA" is used to switch upper-lower case.

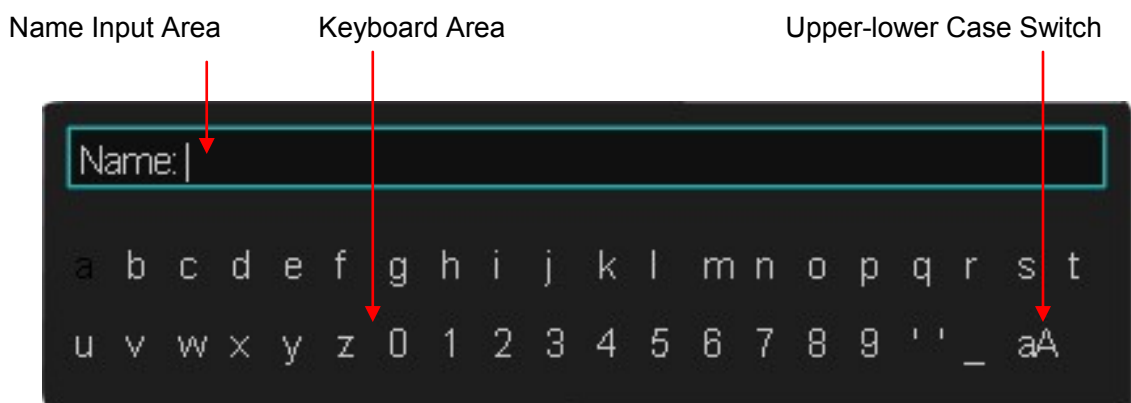

Figure 76 Input Keyboard

4. To delete the name in the name input area, press the **Delete** softkey continuously to delete the character one by one.
5. To input a new name, press the **Switch To** softkey to switch to the keyboard area. The default input method is lower case.
6. Press the ← or the → softkey or turn the **Universal Knob** to select "aA", and then press the **Enter** softkey or push down the **Universal Knob** to set it to "Aa" to set the input method to upper case.
7. Press the ← or the → softkey or turn the **Universal Knob** to select "S" and then press the Enter softkey or the Universal Knob to input the character. Use the same steps to enter the characters "DS2013".
8. Press the ← or the → softkey or turn the **Universal Knob** to select "Aa", and then press the **Enter** softkey or the **Universal Knob** to set it to "aA" to set the input method to lower case.
9. Use the method in step 8 to enter the characters "ab".
10. Press the **Enter** softkey to ensure the file name. You will see a file or folder named "SDS2013ab".

To delete a file or folder

This operation is only valid in external storage.

1. Press the **Save/Recall** button on the front to enter the SAVE/RECALL function menu.
2. Press the **Type** softkey, and then turn the **Universal Knob** to select one of the type (if select Setups, please set the **Save To** option to **External**).
3. Press the **Save** or **Recall** softkey to enter the SAVE/RECAL file system.
4. Turn the **Universal Knob** to select the file or folder to be deleted, and then press the **Delete** softkey. Then the file or folder will be deleted.

To rename a file or a folder

This operation is only valid in external storage.

1. Press the **Save/Recall** button on the front to open the SAVE/RECALL function menu.
2. Press the **Type** softkey, and then turn the Universal Knob to select one of the type (if select Setups, please set the **Save To** option to **External**).
3. Press the **Save** or **Recall** softkey to enter the USB storage device interface.
4. Press the **Next Page** softkey to go to the second page of the SAVE/RECALL function menu.
5. Press the **Rename** softkey, and then refer to the descriptions in “**To Create a new file or fold**” to create a new file name.

System Function Setting

This function module supports the oscilloscope's system-related function, such as system status, language, sound and some other advanced setting, such as do self cal, update and remote interface configure

The contents of this chapter:

- ◆ To View the System Status
- ◆ To Do Self Calibration
- ◆ IO Set
- ◆ To Enable or Disable the Sound
- ◆ To Specify the Language
- ◆ To do Pass/Fail Test
- ◆ To Use the History Function
- ◆ To Print the Screen Image
- ◆ To Enable Quick-Cal
- ◆ To Update Firmware or configuration
- ◆ To Do self Test
- ◆ To Specify the Screen Saver Time
- ◆ Option Management
- ◆ To Set and Display Data/Time

To View the System Status

Do the following steps to view the system status:

1. Press the **Utility** button on the front to enter the UTILITY function menu.
2. Press the **System Status** softkey to view the system status of the oscilloscope. The system status includes the information below:
 - **Startup Times:** record the boot-strap times of the oscilloscope.
 - **Software Version:** list the current software version of the oscilloscope.
 - **Fpga Version:** list the current fpga version of the oscilloscope.
 - **Hardware Version:** list the current hardware version of the oscilloscope.
 - **Product Type:** display the product type of the oscilloscope.
 - **Serial NO.:** list the serial number of the oscilloscope.
 - **Scope ID:** display the scope identification of the oscilloscope.



Figure 77 System Status

3. Press the **Single** button on the front panel to exit.

To Do Self Calibration

The self-calibration program can quickly make the oscilloscope reach the best working state to get the most precise measurement values. You can perform self-calibration at any time especially when the change of the environment temperature is up to or more than 5 °C. Make sure that the oscilloscope has been warmed up or operated for more than 30 minutes before the self-calibration.

Do the following steps to do self calibration:

1. Disconnect all the input channels.
2. Press the **Utility** button on the front panel, and then press the **Do Self Cal** softkey, and the oscilloscope will pop-out the message box shown as below:





Figure 78 Do Self Cal

3. Press the **Single** button on the front panel to perform the self calibration program. During the calibration, most of the keys are disabled.
4. When the self calibration program is finished, it will pop-out the message “**press Run/Stop key to exit**”. Press the **Run/Stop** button on the front panel to exit the calibration interface.

To Enable or Disable the Sound

When the sound is enabled, you can hear the sound of the beeper when you press a function key or a menu softkey or when the prompt message pops up.

Press the **Utility** button on the front panel to enter the UTILITY function menu; then press **Sound** softkey to select  or  to turn on or off the sound.

To Specify the Language

SDS1000X supports multiple language menu, Chinese/English help and prompt messages.

1. Press **Utility** button on the front panel to enter the UTILITY Function menu.
2. Press the **Language** softkey; and then turn the **Universal Knob** to select the desired language. Then push down the knob to select the language.

The languages that currently available are Simplified Chinese, Traditional Chinese, English, French, German, Spanish, Russian, Italian, and Portuguese.

To Do Pass/Fail Test

One way to verify a waveform's compliance to a particular set of parameters is to use pass/fail testing. A pass/fail defines a region of the oscilloscope's display in which the waveform must remain in order to comply with chosen parameters. Compliance to the mask is verified point- by- point across the display.

The test results can be displayed on the screen as well as be declared through the system sound or the pulse signal output from the **[TRIG OUT]** connector at the rear panel. Pass/Fail test operates on displayed analog channels; it does not operate on channels that are not displayed.

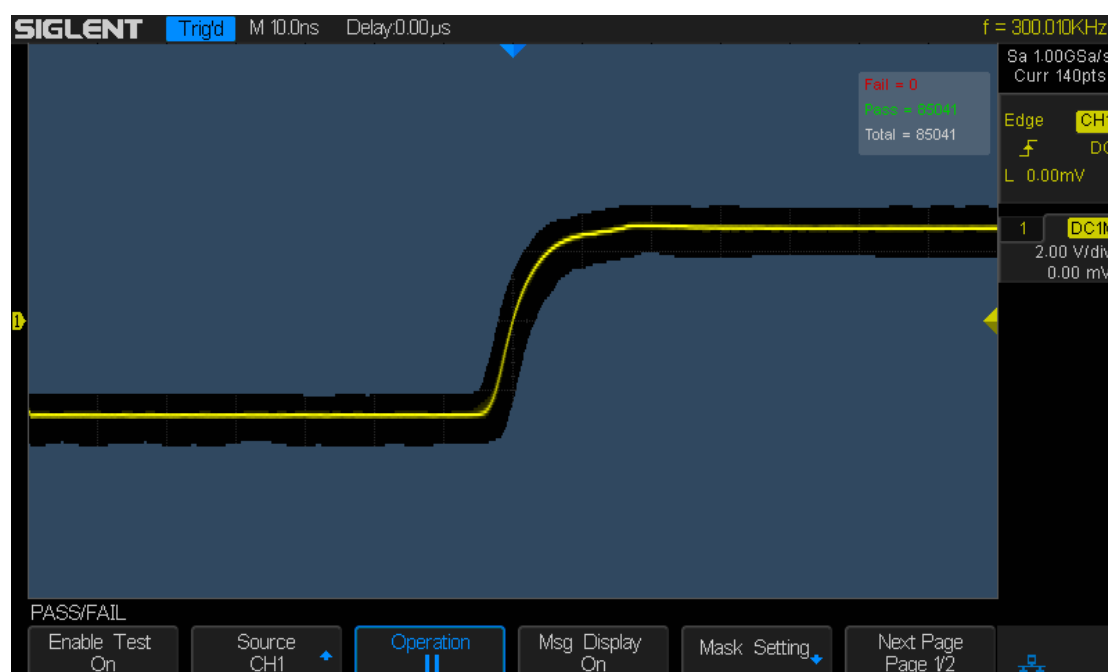
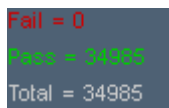

Figure 79 Pass/Fail Test





To Set and Perform Pass/Fail Test

Do the following steps to set and perform pass/fail test:

1. Press the **Utility** button on the front panel to enter the UTILITY function menu.
2. Press the **Next Page** softkey to go to the second page of the UTILITY function menu.
3. Press the **Pass/Fail** softkey to enter the PASS/FAIL function menu.
4. Press the **Enable Test** softkey to select **On** to enable the pass/ fail test.
5. Press the **Source** softkey to select the desired channel.
6. Press the **Mask Setting** softkey to enter the MASK function menu.
7. Press the **X Mask** or **Y Mask** softkey; and then turn the **Universal Knob** to select the desired value. The range is from 0.02div to 4div.
8. Press the **Create Mask** button to create the mask. Whenever the **Create Mask** softkey is pressed the old mask is erased and a new mask is created.
9. Press the **UP** softkey to return to the PASS/FAIL function menu.
10. Press the **Msg Display** to select **On** or **Off** to turn on or off the message display. When **On** is selected, the test result will be displayed in the upper-right message box of the screen.



Fail = 0
Pass = 34985
Total = 34985

- **Fail:** the frame number of the channel waveform that fails to match the mask.
 - **Pass:** the frame number of the channel waveform that matches the mask.
 - **Total:** the frame number of the channel waveform that have been acquired. It is the total of **Pass** and **Fail**.
11. Press the Next Page softkey to go to the second page of the PASS/FAIL function menu.
 12. Press the Fail softkey to select On or Off to turn on or off the function.
 - **On:** when failed waveforms are detected, the oscilloscope will stop the test and enter the STOP state. At this point, the results of the test remain the same on the screen (if display is turned on) and only one pulse is output from the **[TRIG OUT]** connector (if enabled) at the rear panel.
 - **Off:** the oscilloscope will continue with the test even though failed waveforms are detected. The test results on the screen will update continuously and a pulse will be output from the **[Trigger Out]** connector at the rear panel each time a failed waveform is detected.
 13. Press the Output softkey to select turn on or off the sound.
 -  : When the failed waveforms are detected, the beeper sounds.
 -  : The beeper will not sound even if the failed waveforms are detected,
 14. Press the Next Page softkey to return to the first page of the PASS/FAIL function menu.
 15. Press the Operate softkey to perform the test.
 -  : Current state is stop; press the softkey to start the pass/fail test.
 -  : Current state is running; press the softkey to stop the pass/fail test.

To Save and Recall Test Mask

Users can save the current test mask to the internal Flash memory or external USB flash device. The file format of the test mask file is “*.RGU”.

➤ Save Test Mask to Internal Memory

1. Press the **Utility** button on the front panel to enter the UTILITY function menu.
2. Press the **Next Page** softkey to go to the second page of the UTILITY function menu.
3. Press the **Pass/Fail** softkey to enter the PASS/FAIL function menu.
4. Press the **Enable Test** softkey to select **On** to enable the pass/ fail test.
5. Press the **Source** softkey to select the desired channel.
6. Press the **Mask Setting** softkey to enter the MASK function menu.
7. Press the **X Mask** or **Y Mask** softkey; and then turn the **Universal Knob** to select the desired value.
8. Press the **Location** softkey to select **Internal**
9. Press the **Save** softkey to save the mask to internal memory.
10. A few second later, it will pop-out the message “**Store Data Success!**”

Note: the internal memory can only save one test mask; save a new test mask will cover the old one.

➤ Recall Test Mask from Internal Memory

1. Press the **Utility** button on the front panel to enter the UTILITY function menu.
2. Press the **Next Page** softkey to go to the second page of the UTILITY function menu.
3. Press the **Pass/Fail** softkey to enter the PASS/FAIL function menu.
4. Press the **Enable Test** softkey to select **On** to enable the pass/ fail test.
5. Press the **Mask Setting** softkey to enter the MASK function menu.
6. Press the **Location** softkey to select **Internal**.
7. Press the **Load** softkey to recall the saved interval memory.
8. A few second later, it will pop-out the message “**Read Data Success!**” and the saved mask will be displayed on the screen.

➤ **Save Test Mask to External Memory**

Do the following steps to save the test mask to external memory:

1. Press the **Utility** button on the front panel to enter the UTILITY function menu.
2. Press the **Next Page** softkey to go to the second page of the UTILITY function menu.
3. Press the **Pass/Fail** softkey to enter the PASS/FAIL function menu.
4. Press the **Enable Test** softkey to select **On** to enable the pass/ fail test.
5. Press the **Source** softkey to select the desired channel.
6. Press the **Mask Setting** softkey to enter the MASK function menu.
7. Press the **X Mask** or **Y Mask** softkey; and then turn the **Universal Knob** to select the desired value.
8. Press the **Location** softkey to select **External**
9. Press the **Save** softkey to enter the file SAVE/RECALL system.
10. Save the test mask file refer to the “**Save and Recall**” chapter.

➤ **Recall Test Mask from External Memory**

Do the following steps to save the test mask f external memory:

1. Press the **Utility** button on the front panel to enter the UTILITY function menu.
2. Press the **Next Page** softkey to go to the second page of the UTILITY function menu.
3. Press the **Pass/Fail** softkey to enter the PASS/FAIL function menu.
4. Press the **Enable Test** softkey to select **On** to enable the pass/ fail test.
5. Press the **Mask Setting** softkey to enter the MASK function menu.
6. Press the **Location** softkey to select **External**
7. Press the **Load** softkey to enter the file SAVE/RECALL system.
8. Select the desired test mask file with a RGU postfix using the **Universal Knob**; and then press the **Load** softkey.

IO Set

SDS1000X provides abundant IO interfaces, including: USB Device, LAN and Aux Output.

To Set the USB Device

Do the following steps to set the oscilloscope to communicate with PC via USB:

1. Install the USBTMC device driver on PC. Suggest you install NI Vista.
2. Connect the oscilloscope with PC using a standard USB cable
3. Press the **Utility** button on the front panel to enter the UTILITY function menu.
4. Press the **IO Set** softkey to enter the I/O SET function menu.
5. Press the **USB Device** softkey to select **USBTMC**.
6. Use EasyScopeX or NI Vista to communicate with the oscilloscope.

Do the following steps to set the oscilloscope to print the screen image:

1. Connect the oscilloscope with print using a standard USB cable.
2. Press the **Utility** button on the front panel to enter the UTILITY function menu.
3. Press the **IO Set** softkey to enter the I/O SET function menu.
4. Press the **USB Device** softkey to select **Printer**.
5. Press the Print button on the front panel to print the screen image.

To Set the LAN

Do the following steps to set the oscilloscope to communicate with PC via LAN:

1. Connect the oscilloscope to your local area network using the network cable.
2. Press the **Utility** button on the front panel to enter the UTILITY function menu.
3. Press the **IO Set** softkey to enter the I/O SET function menu.
4. Press the **LAN** softkey to enter the LAN setting interface, see the picture below:

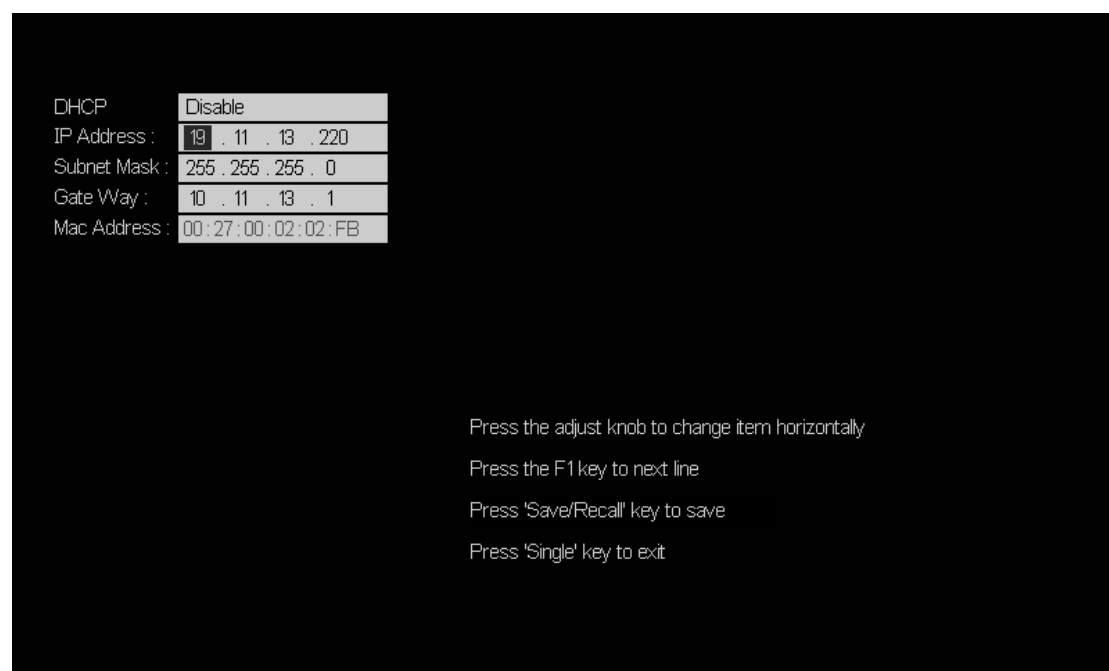

Figure 80 LAN Setting Interface

5. Press the F1 softkey (the first softkey below the screen) continually to go to the DHCP line; then turn the **Universal Knob** to select Enable or Disable.
 - **Enable:** the DHCP server in the current network will assign the network parameters (such as the IP address) for the oscilloscope.
 - **Disable:** you can set the IP address, subnet mask, gate way manually.
 - Turn the **Universal Knob** to select the desired value.
 - Push the **Universal Knob** to change item horizontally.
 - Press the **F1** softkey to go to the next line.
 - Press the **Save/Recall** softkey to save the current setting.
 - Press the **Single** button to exit the setting interface.
6. Use EasyScopeX or NI Vista to communicate with the oscilloscope.

To Set Aux Output

Users can set the type of the signal output from the **[Trigger Out]** connector at the rear panel.

1. Press the **Utility** button on the front panel to enter the UTILITY function menu.
2. Press the **IO Set** softkey to enter the I/O SET function menu.
3. Press the Aux Output softkey to select Trig Out or Pass/Fail. The default setup is **Trig Out**.
 - **Trig Out:** if this type is selected, the oscilloscope outputs a signal that can reflect the current capture rate of the oscilloscope at each trigger. The maximal capture rate of SDS1000X is 110k wfs/s.
 - **Pass/Fail:** if this type is selected, the oscilloscope will output a pulse signal when failed waveforms are detected. This signal can be connected to other control systems to conveniently view the test results.

To Enable Quick-Cal

Quick-Cal can calibrate the measure deviation which cause by the temperature. If the temperature that the SDS1000X is working is not stable, do the following steps:

1. Press the **Utility** button on the front panel to enter the UTILITY function menu.
2. Press the **Next Page** softkey to go to the second page of the UTILITY function menu.
3. Press the **Quick-Cal** to select **On**.

If the Quick-Cal has been set to **On** before powering on, and the current vertical scale is 2mV or 5mV of any channel, the oscilloscope will perform the quick calibration procedure when it powers on. During the calibration, most of the buttons are disabled.

Also, when the Quick-Cal is **On** and the current vertical scale is 2mV or 5mV of any channel, the oscilloscope will perform the quick calibration procedure if the operating temperature changes by more than 2 degree.

To Update Firmware and Configuration

The firmware and configuration can be updated directly via USB flash driver.

Do the following steps to update the firmware:

1. Insert the USB flash driver which with the firmware and the configure files inside into the USB host interface on the front panel of the oscilloscope.
2. Press the **Utility** button on the front panel to enter the UTILITY function menu.
3. Press the **Next Page** softkey to go to the second page of the UTILITY function menu.
4. Press the **Next Page** softkey to go to the third page of the UTILITY function menu.
5. Press the **Update** softkey to enter the UPDATE function menu.
6. Press the **Firmware** softkey and it will pop-out the message “**Press ‘Single’ to continue and press ‘Run/Stop’ to exit!**”
7. Press the **Single** button to enter the SAVE/RECALL file system.
8. Turn the **Universal Knob** to select the update file which should be with an ADS postfix; and then press the **Load** softkey to start update the firmware. The process needs about 7 minutes. And during the update, do not cut off the oscilloscope, otherwise the oscilloscope will not restart again.
9. After finish the update, the screen will pop-out the message “**Update success, please restart the DSO**”, and you will heard a sound of buzzer.
10. Restart the oscilloscope to finish the firmware update.

Do the following steps to update the configuration:

1. Insert the USB flash driver which with the firmware and the configure files inside into the USB host interface on the front panel of the oscilloscope.
2. Press the **Utility** button on the front panel to enter the UTILITY function menu.
3. Press the **Next Page** softkey to go to the second page of the UTILITY function menu.
4. Press the **Next Page** softkey to go to the third page of the UTILITY function menu.
5. Press the **Update** softkey to enter the UPDATE function menu.
6. Press the **Configure** softkey to enter the SAVE/RECALL file system.
7. Turn the **Universal Knob** to select the update file which should be with an CFG postfix; and then press the **Load** softkey to start update the firmware. The process needs about 30 seconds.
8. After finish the update, the screen will pop-out the message “**Update success, please restart the DSO**”, and you will heard a sound of buzzer.
9. Restart the oscilloscope to finish the configuration update.

Do Self Test

Self tests include screen test, keyboard test, and LED test. Self tests used to test the screen, buttons, knobs and LED lights whether works well.

Screen Test

1. Press the **Utility** button on the front panel to enter the UTILITY function menu.
2. Press the **Next Page** softkey to go to the second page of the UTILITY function menu.
3. Press the **Next Page** softkey to go to the third page of the UTILITY function menu.
4. Press the **Do Self Test** softkey to enter the SELFTEST function menu.
5. Press the **Screen Test** softkey to enter the screen test interface, as the picture shown below, the screen display pure red.

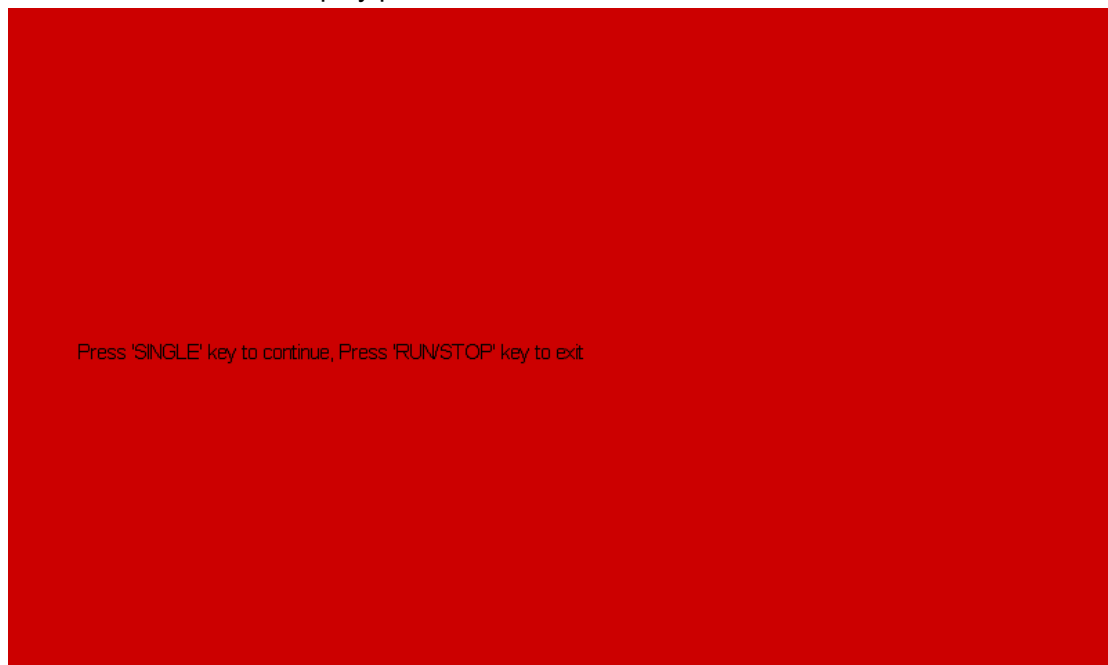

Figure 81 Screen Test

6. Press the **Single** button on the front panel continually as it says in the picture above. The screen displays green, blue and red again. It is easy to check chromatic aberration, stain and scratch of the screen under the condition.
7. Press the **Run/Stop** button on the front panel to exit the screen test program.

Keyboard Test

Keyboard test is used to test that if the keys or the knobs work well.

Do the following steps to do keyboard test:

1. Press the **Utility** button on the front panel to enter the UTILITY function menu.
2. Press the **Next Page** softkey to go to the second page of the UTILITY function menu.
3. Press the **Next Page** softkey to go to the third page of the UTILITY function menu.
4. Press the **Do Self Test** softkey to enter the SELFTEST function menu.
5. Press the **Keyboard Test** softkey to enter the keyboard test interface, as the picture shown below.

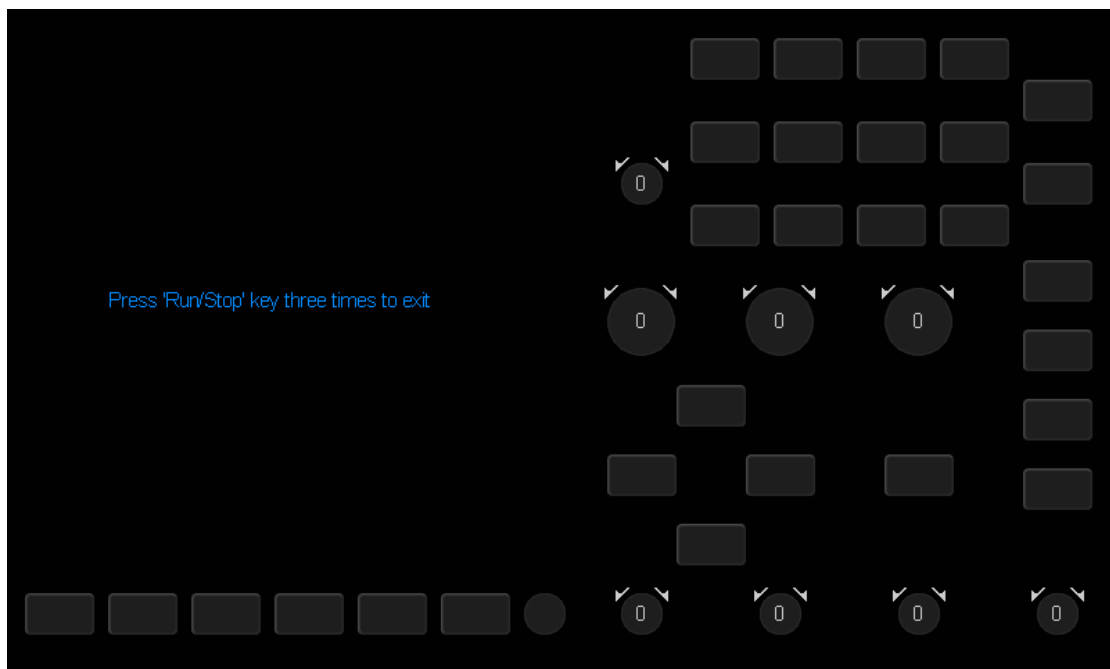

Figure 82 Keyboard Test

6. To perform the knobs and the buttons test.
Knobs test: the default value is 0. Turn left to increase the value while turn right to decrease; push the knob to set the value to 0. Test every knob randomly.
Keys test: the first time to press the key to light it up, and a second press to die out. Test every button randomly.
7. Press the **Run/Stop** button 3 times to exit the keyboard test program.

LED Test

LED test is used to test that if the button lights work well.

1. Press the **Utility** button on the front panel to enter the UTILITY function menu.
2. Press the **Next Page** softkey to go to the second page of the UTILITY function menu.
3. Press the **Next Page** softkey to go to the third page of the UTILITY function menu.
4. Press the **Do Self Test** softkey to enter the SELFTEST function menu.
5. Press the **LED Test** softkey to enter the keyboard test interface, as the picture shown below.



Figure 83 LED Test

6. According to the prompting information displaying on the screen, press the **Single** button continually to light the button lights one by one. The first time to press the **Single** button, the **Run/Stop** button displays red, and the second press the **Run/Stop** button displays green. Then the other button lights will be lighted one by one. At last all the lights will be lighted at the same time.
7. Press the **Run/Stop** button to exit the LED test program.

To specify Screen Saver Time

When the oscilloscope enters the idle state and holds for a certain period of time, the screen saver program will be enabled.

Do the following steps to set the screen saver time:

1. Press the **Utility** button on the front panel to enter the UTILITY function menu.
2. Press the **Next Page** softkey to go to the second page of the UTILITY function menu.
3. Press the **Next Page** softkey to go to the third page of the UTILITY function menu.
4. Press the **Screen Saver** softkey; and then turn the **Universal Knob** to select the desired screen saver time. The screen saver time can be set to **1min**, **5min**, **10min**, **30min**, and **1hour**. Also you can select **Off** to turn off the screen saver function

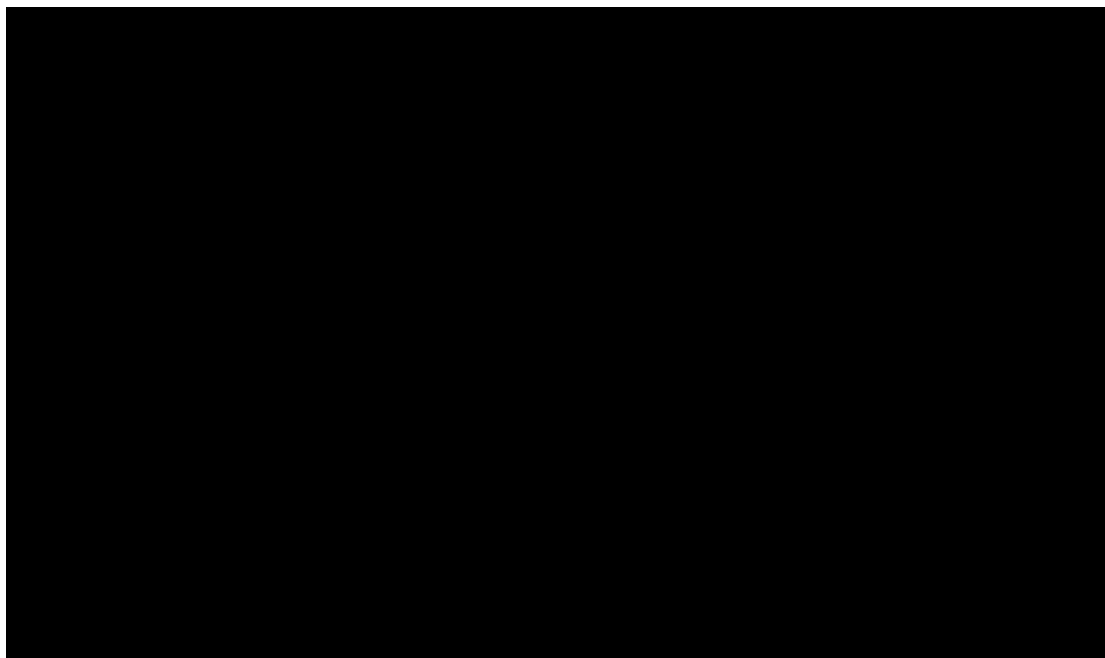

Figure 84 Screen Saver Interface

5. Press the any button on the front to exit the screen saver program.

Option Management

SDS1000X provides multiple options to fulfill your measurement requirements. Please contact your **SIGLENT** sales representative or **SIGLENT** technical support to order the corresponding options. You can view the options currently installed on the oscilloscope or activate the newly bought option serial number through this menu.

Do the following steps to install the option on the oscilloscope:

1. Press the **Utility** button on the front panel to enter the UTILITY function menu.
2. Press the **Next Page** softkey to go to the second page of the UTILITY function menu.
3. Press the **Next Page** softkey to go to the third page of the UTILITY function menu.
4. Press the **Options** softkey to enter the OPTION function menu.



Figure 85 OPTION Function Menu

5. Press the **Type** softkey; then turn the **Universal Knob** to select the module to be installed and push down the knob to confirm.
6. Press the **License** softkey to enter the LABEL function menu to input the license.

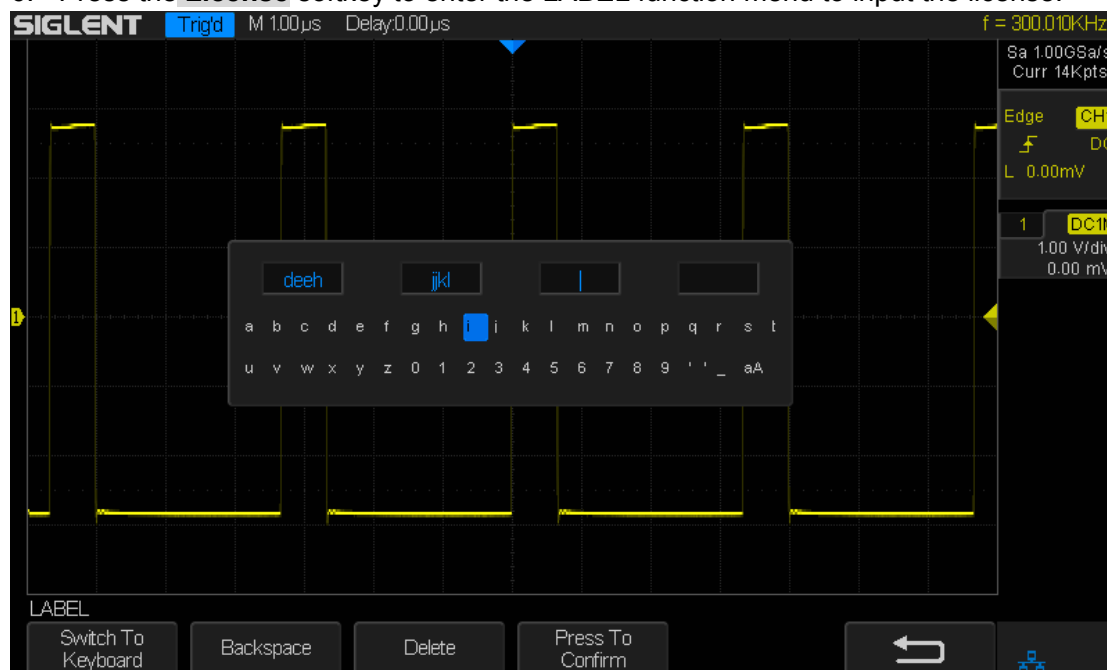

Figure 86 LABEL Function Menu

- When the **Switch To** Softkey is set to **Keyboard**:
 - Turn the **Universal Knob** or press the **←** softkey and the **→** softkey to select character; Push down the **Universal Knob** or press the **Enter** softkey to input the character.
 - Press the **Delete** softkey to delete the incorrect character.
- When the **Switch To** softkey is set to **License**:

- Turn the **Universal Knob** or press the **←** softkey and the **→** softkey to select character;
- Push down the **Universal Knob** or press the **Enter** softkey to confirm the characters and the oscilloscope will activate the corresponding option using the license key currently input.
- Press the **Delete** softkey to delete the incorrect character.

7. Press the Information softkey to view the option information.

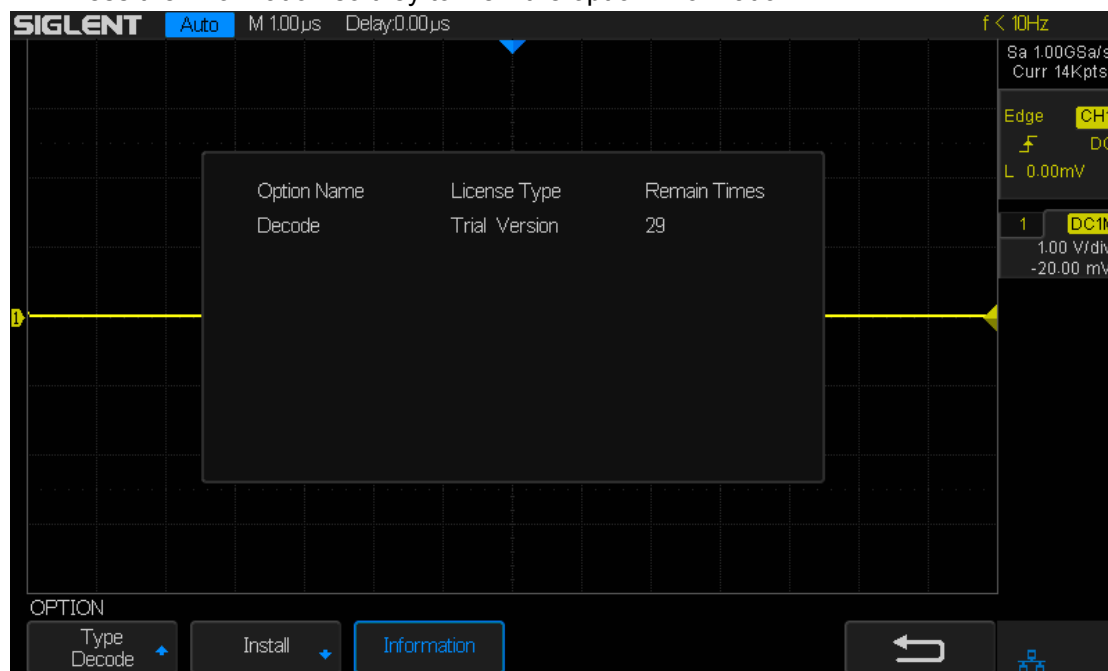

Figure 87 Option Information

To Use the History Function

The history function can record the waveforms of the input channels before press the **Run/Stop** button. In run state, the oscilloscope records input waveform continually; when fill up the memory (reach the maximal frame), the new frames will cover the old frames and keep the latest frames.

To use the History function, the HORIZONTAL **Format** must be set to **YT**.

Do the following steps to record and replay waveform:

- Press the **History** button on the front to enable the History function.
 - When in run state, the waveform will enter the stop state.
 - When in stop state, and then enable the History function, the oscilloscope will keep the stop state.
 - Press **History** and **Stop** button to turn off History function.
- Press the **List** softkey to turn on or off the list display. The list records the timestamp of every frame. It is accurate to microseconds.

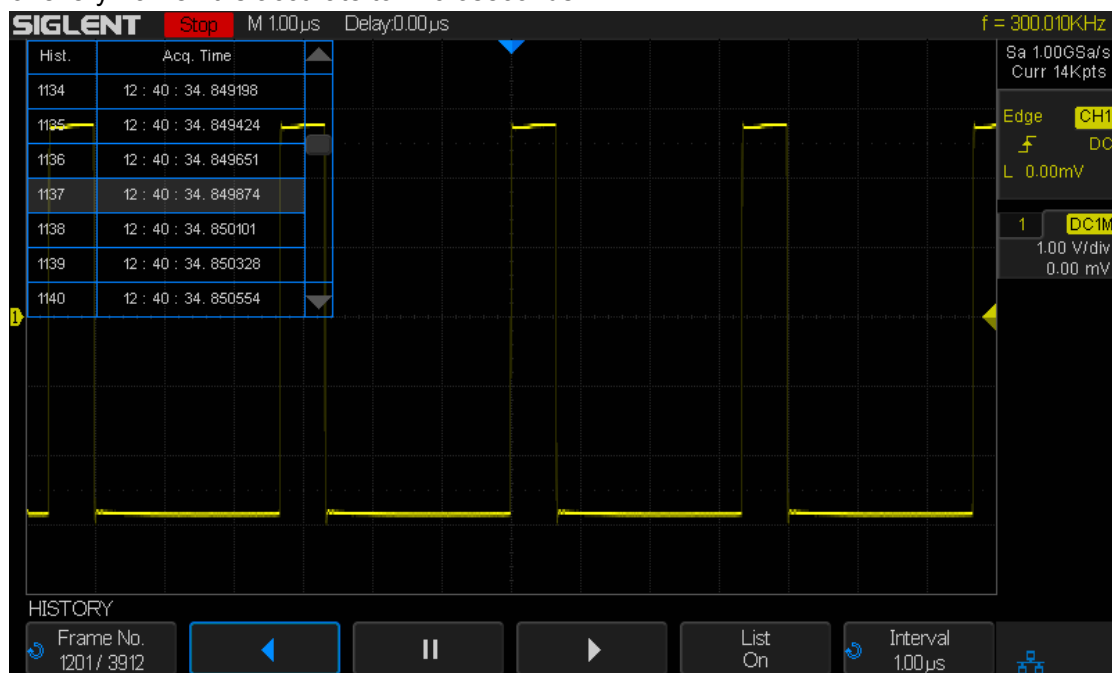





Figure 88 History

- Press the **Frame** softkey; then turn the **Universal Knob** to select the frame to display.
 - The format of the **Frame** is A/B; A is the frames number that displaying on the screen and B is the maximal frame number you can set.
 - The maximal frame number is determined by the current sampling point (**Curr** value) and sampling rate.
 - When press the **Run/Stop** button or enable the history function, you may not get the maximal frames, because the memory is not filled. So if you want to get the maximal frames, please wait for enough time for acquisition.

The table shows the maximal frame according to the sampling rate and current

sampling point's number.

Sample Rate	Curr (pts)	Max. Frame	Sample Rate	Curr (pts)	Max. Frame
1GSa/s	≅ 280	80000	500MSa/s	35K	783
	700	57227		70K	391
	1.4K	33528		140K	195
	2.8K	18338		350K	77
	7K	7773		700K	38
	14K	3982		1.4M	18
	28K	1993		3.5M	6
	70K	798		7M	3
	140K	398		14M	1
	280K	198		≤250MSa/s	3.5K
	700K	78	7K		1891
	1.4M	38	14K		945
	2.8M	18	17.5K		757
	7M	7	35K		378
	14M	3	70K		188
	500MSa/s	≅ 35	80000	140K	93
70		77026	175K	74	
140		65667	700K	17	
350		45526	1.4M	8	
700		29140	1.8M	6	
1.4K		16945	3.5M	3	
3.5K		7510	7M	1	
7K		3912	14M	1	
14K		1958			

4. Press the  softkey to replay the waveform from the current frame to 1.
5. Press the  softkey to stop replay.
6. Press the  softkey to replay the waveform from the current frame to the last frame.

Arbitrary Waveform Generator

SDS1000X supports build-in Arbitrary waveform generator.

SDS1000X build-in Arbitrary waveform generation provides sine, square, ramp, pulse, DC, noise, cardiac, Gauss pulse, exp rise, exp fall and Arbitrary waveforms.

The contents of this chapter:

- ◆ To Set Wave Type and Parameters
- ◆ To Output Arbitrary Waveform
- ◆ To Set Output Load
- ◆ To Recover Default Setup
- ◆ To Do AWG Self Cal

To Set Wave Type and Parameters

1. Press the **WaveGen** button on the front panel to open the build-in Arbitrary waveform generation function. The first press lights up the backlight of the button, opens the output and enters the WAVEFORM function menu. A second press of the **WaveGen** button will turn off the backlight and the output.
2. Press the **Wave Type** softkey; then turn the **Universal Knob** to select the desired waveform and push down the knob to confirm. Press the Wave Type softkey continually can also select the waveform type.
3. Press the **Frequency** softkey; then turn the **Universal Knob** to select **Frequency**, **Frequency Fine**, **Period** or **Period Fine** and push down the knob to confirm; turn the **Universal Knob** to select the desired value. Use the same method the set the other parameters.

Wave Type	Character	Frequency Range	Amplitude (High-Z)	Offset (High-Z)
Sine	Use the Universal Knob to adjust the Frequency/ Frequency Fine/ Period/ Period Fine/ Amplitude/ Amplitude Fine/ High-Level/ High-Level-Fine/ Offset/ Offset Fine/ Low-Level/ Low-Level-Fine value.	1uHz~25MHz	4mV~6V	± 3.0V
Square	Use the Universal Knob to adjust the Frequency/ Frequency Fine/ Period/ Period /Fine/ Amplitude/ Amplitude Fine/ High-Level/ High-Level-Fine/ Offset/ Offset Fine/ Low-Level/ Low-Level-Fine/ Duty value.	1uHz~10MHz	4mV~6V	± 3.0V
Ramp	Use the Universal Knob to adjust the Frequency/ Frequency Fine/ Period/ Period Fine/ Amplitude/ Amplitude Fine/ High-Level/ High-Level-Fine/ Offset/ Offset Fine/ Low-Level/ Low-Level-Fine/ Symmetry value.	1uHz~300KHz	4mV~6V	± 3.0V
pulse	Use the Universal Knob to adjust the Frequency/ Frequency Fine/ Period/ Period /Fine/ Amplitude/ Amplitude Fine/ High-Level/ High-Level-Fine/	1uHz~10MHz	4mV~6V	± 3.0V

	Offset/Offset Fine/ Low-Level/ Low-Level-Fine/ Width/ Width Fine value.			
DC	Use the Universal Knob to adjust the Offset value.			± 3.0V
Noise	Use the Universal Knob to adjust the Stdev/ Mean value.			
Cardiac	Use the Universal Knob to adjust the Frequency/ Frequency Fine/ Period/ Period /Fine/ Amplitude/ Amplitude Fine/ High-Level/ High-Level-Fine/ Offset/Offset Fine/ Low-Level/ Low-Level-Fine value.	1uHz~5MHz	4mV~6V	± 3.0V
Gaus Pulse	Use the Universal Knob to adjust the Frequency/ Frequency Fine/ Period/ Period /Fine/ Amplitude/ Amplitude Fine/ High-Level/ High-Level-Fine/ Offset/Offset Fine/ Low-Level/ Low-Level-Fine value.	1uHz~5MHz	4mV~6V	± 3.0V
Exp Rise	Use the Universal Knob to adjust the Frequency/ Frequency Fine/ Period/ Period /Fine/ Amplitude/ Amplitude Fine/ High-Level/ High-Level-Fine/ Offset/Offset Fine/ Low-Level/ Low-Level-Fine value.	1uHz~5MHz	4mV~6V	± 3.0V
Exp Fai;	Use the Universal Knob to adjust the Frequency/ Frequency Fine/ Period/ Period /Fine/ Amplitude/ Amplitude Fine/ High-Level/ High-Level-Fine/ Offset/Offset Fine/ Low-Level/ Low-Level-Fine value.	1uHz~5MHz	4mV~6V	± 3.0V
When the Output Load is set to 50Ω , all the value will be the half.				

To Output Arbitrary Waveform

1. Press the **Wave Gen** button on the front panel to enable the AWG function and enter the WAVEFORM function menu.
2. Connect the SDS1000X with PC which has installed the EasyWave software using a USB cable.
3. Double click the EasyWave icon to run it.
4. Select a waveform file or draw an arbitrary waveform; then click the **Send wave** option which at the bottom of the interface and it will pop-up the dialogue which shows as the picture below:

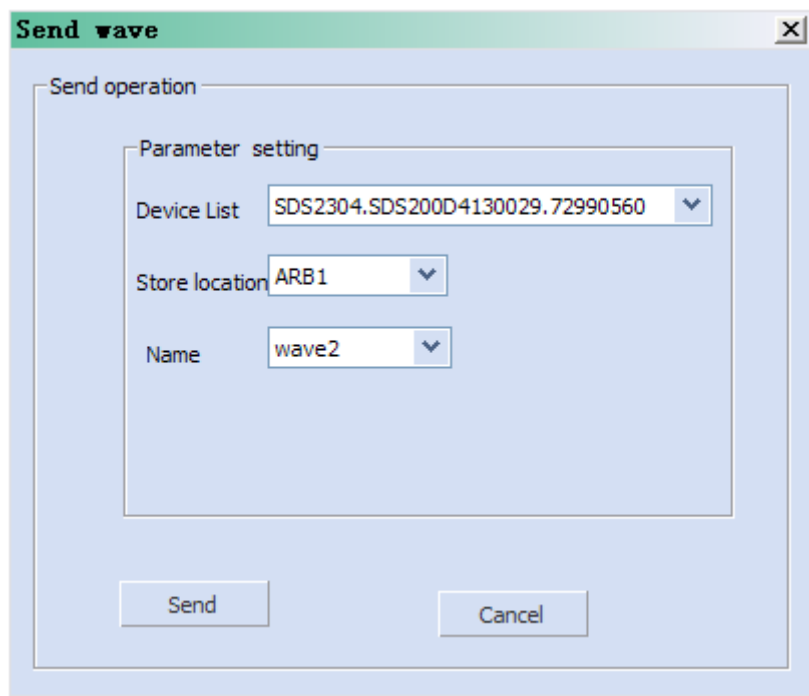

Figure 89 Send Wave Dialogue

5. Click the Store location area and select the location to keep the arbitrary waveform.
6. Click the Send option, then the oscilloscope will pop-out the message “Dealing with waveform data, please wait...”
7. A few seconds later the oscilloscope will prompt “Succeed to save waveform”, and it will enter the WAVEFORM function menu, the Wave Type sets to ArbX (the location chose above)



Figure 90 Save Waveform Successfully

8. If you want to delete the arbitrary waveform, press the **Delete** softkey.
9. Press the **Setting** softkey to enter the SETTING function menu.
10. Press the **Output Load** softkey to select **High-Z** or **50Ω**.

To Set Output Load

11. Press the **Wave Gen** button on the front panel to enter the WAVEFORM function menu.
12. Press the **Setting** softkey to enter the SETTING function menu.
13. Press the **Output Load** softkey to select **High-Z** or **50Ω**.

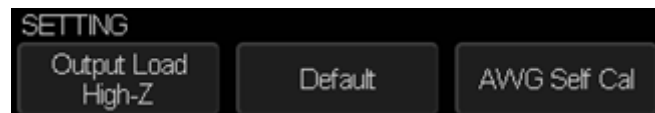

Figure 91 SETTING Function Menu

The output load of the Wave Gen must match with the oscilloscope, or the amplitude of the signal will be incorrect.

Recover the Default Values of Wave Gen.

1. Press the **Wave Gen** button on the front panel to enter the WAVEFORM function menu.
2. Press the **Setting** softkey to enter the SETTING function menu.
3. Press the **Default** softkey to recover the default values of Wave Gen (Sine, 1.000 KHz, 4.000Vpp, 0.0mVdc).

AWG Self Cal

If the operating temperature changes more than 5° and the instrument runs more than more 30 minutes, you should do the AWG Self Cal to decrease the mistake.

1. Press the **Wave Gen** button on the front panel to enter the WAVEFORM function menu.
2. Press the **Setting** softkey to enter the SETTING function menu.
3. Press the **AWG Self Cal** softkey to perform AWG self calibration program.





Figure 92 AWG Self Cal

4. When the self calibration program is finish, press the **Run/Stop** button on the front panel to exit the interface according to the information on the screen.

Default Setup

Press the Default button on the front to set the SDS1000X to the leave factory setup. The details show as below.

Horizontal	
T/div	1 μ S/div
Delay	0 S
Zoom	Off
Format	Y-T
Vertical	
Channel on/off	CH1
V/div	1 V/div
Offset	0 V
Coupling	DC
BW Limit	Full
Adjust	Coarse
Probe	1X
Impedance	1 M Ω
Unit	V
Invert	Off
Acquire	
Acquisition	Normal
Sinx/x	Sinx
Mem Depth	14 Mpts
Trigger	
Type	Edge
Source	CH1
Slope	Rising
Holdoff	Off
Coupling	DC
Noise Rejest	Off
Mode	Auto
Display	
Type	Vectors
Color	Off

Persist	Off
Grid	
Intensity	50%
Brightness	40%
Transparence	50%
Cursor	
Mode	Off
Type	X1
Source	CH1
X1	-3.5µs
X2	3.5µs
Save/Recall	
Type	Setups
Save To	Internal
Setup	NO.1
Utility	
IO Set	
USB Device	USBTMC
Aux Output	Trig Out
Sound	
Sound	On
Pass/Fail	
Enable Test	Off
Source	CH1
Operate	Off
Mes Display	Off
X Mask	0.2
Y Mask	0.2
Location	Internal
Fail To Stop	Off
Output	
System Setup	
Quick-Cal	Off
Screen Saver	30min
Math	

Operate	Off
+	
Source A	CH1
Source B	CH1
Invert	Off
V/div	1.00 V/div
offset	0V
-	
Source A	CH1
Source B	CH1
Invert	Off
V/div	1.00 V/div
offset	0 V
*	
Source A	CH1
Source B	CH1
Invert	Off
V/div	1.00 V ² /div
offset	0 V ²
/	
Source A	CH1
Source B	CH1
Invert	Off
V/div	1.0/div
offset	0
FFT	
Source	CH1
Window	Hanning
Horizontal	1X
Vertical Scale	20 dBVrms
Display	Split
Horizontal Scale	100MHz
d/dt	
Source	CH1
Vertical Scale	1.00 (MV/S)/div
Vertical Offset	0
dx	0.2 div
∫dt	
Source	CH1
Offset	0

Vertical Scale	1.00 μ V/div
Vertical Offset	0
√	
Source	CH1
Vertical Scale	1.00 V ^{1/2} /div
Vertical Offset	0
REF	
Source	CH1
Location	REF A
Display	Off
Decode	
Serial 1	
Serial	I2C
Display	Off
List	Off
Serial 2	
Serial	SPI
Display	Off
List	Off
I2C	
SCK	CH1
Threshold	1.60V
SDK	CH2
Threshold	1.60V
Address	7 位
SPI	
CLK	CH1
Threshold	1.60V
Edge Select	Rising
MISO	CH2
Threshold	1.60V
MOSI	CH1
Threshold	1.60V
CS Type	CS
CS	CH2
Idle Level	Low
Bit Order	LSB
Data Length	8

UART/RS232	
RX	CH1
Threshold	1.60V
TX	CH2
Threshold	1.60V
Bound	9600
Parity Check	None
Stop Bit	1
Idle Level	Low
Data Length	8
CAN	
CAN-H	CH1
Threshold	1.60V
CAN-L	CH2
Threshold	1.60V
Bound	100kb/S
Decode Source	CAN_H
LIN	
Source	CH1
Threshold	1.60V
Baud	2400
Wave Gen	
Function	Off
Wave Type	Sine
Output Load	High-Z
Sine	
Frequency	1 KHz
Amplitude	4 Vpp
Offset	0 Vdc
Square	
Frequency	1 KHz
Amplitude	4 Vpp
Offset	0 Vdc
Duty	50%
Ramp	
Frequency	1 KHz
Amplitude	4 Vpp
Offset	0 Vdc
Symmetry	50%

Pulse	
Frequency	1 KHz
Amplitude	4 Vpp
Offset	0 Vdc
Width	200 μ s
DC	
Offset	0.0mVdc
Noise	
Stdev	448 mV
Mean	0 mV
Cardiac	
Frequency	1 KHz
Amplitude	4 Vpp
Offset	0 Vdc
Gaus Pulse	
Frequency	1 KHz
Amplitude	4 Vpp
Offset	0 Vdc
Exp Rise	
Frequency	1 KHz
Amplitude	4 Vpp
Offset	0 Vdc
Exp Fall	
Frequency	1 KHz
Amplitude	4 Vpp
Offset	0 Vdc

Troubleshooting

The commonly encountered failures and their solutions are listed below. When you encounter those problems, please solve them following the corresponding steps. If the problem remains still, please contact **SIGLENT** Company as soon as possible.

1. **The screen is still dark (no display) after power on:**
 - 1) Check whether the power is correctly connected.
 - 2) Check whether the power switch is really on.
 - 3) Check whether the fuse is burned out. If the fuse needs to be changed, please use the specified fuse.
 - 4) Restart the instrument after finishing the above inspections.
 - 5) If it still does not work correctly, please contact **SIGLENT**.

2. **The signal is sampled but no waveform of the signal is displayed:**
 - 1) Check whether the probe is correctly connected to the signal connecting wire.
 - 2) Check whether the signal connecting wire is correctly connected to the BNC (namely channel connector).
 - 3) Check whether the probe is correctly connected to the item to be tested.
 - 4) Check whether there are signals generated from the item to be tested (you can connect the probe compensation signal to the problematic channel to determine which has problem, the channel or the item to be tested).
 - 5) Resample the signal.

3. **The tested voltage amplitude is greater or lower than the actual value (note that this problem usually occurs when probe is used):**

Check whether the attenuation coefficient of the channel complies with the attenuation ratio of the probe.

4. **There is waveform display but not stable:**
 - 1) Check the trigger signal source: check whether the **Source** item at the trigger panel complies with the signal channel actually used.
 - 2) Check the trigger type: general signals should use "Edge" trigger and video signal should use "Video" trigger. Only when the proper trigger type is used, can the waveform be displayed stably.
 - 3) Change the trigger holdoff setting.

5. **No display after pressing Run/Stop:**

Check whether the mode at the trigger panel (TRIGGER) is on "Normal" or "Single" and whether the trigger level exceeds the waveform range. If yes, set the trigger level to the middle or set the mode to "Auto".

Note: using **AUTO** could automatically finish the above setting.

6. The display of waveform is ladder-like:

- 1) The horizontal time base might be too low. Increase the horizontal time base to increase the horizontal resolution and improve the display.
- 2) If the display **Type** is "Vectors", the lines between the sample points may cause ladder-like display. Set **Type** to "Dots" to solve the problem.

7. Fail to connect PC through USB:

Check the **IO Setting** in **Utility** to make sure whether the setting in **USB Device** matches the device currently connected. If needed, restart the oscilloscope.

8. The USB storage device cannot be recognized:

- 1) Check whether the USB storage device can work normally.
- 2) Make sure whether the USB interface can work normally.
- 3) Make sure that the USB storage device being used is flash storage type. This oscilloscope does not support hardware storage type.
- 4) Make sure whether the system of the USB storage device is FAT32.
- 5) Restart the instrument and then insert the USB storage device to check it.
- 6) If the USB storage device still cannot be used normally, please contact **SIGLENT**.

