

Instruction Manual

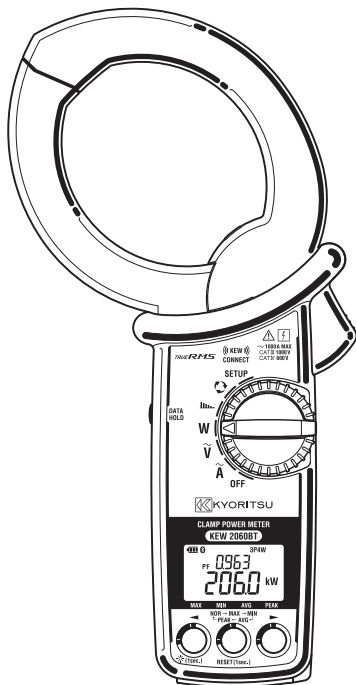



CLAMP POWER METER

KEW 2060BT



KYORITSU ELECTRICAL INSTRUMENTS WORKS, LTD.

Unpacking	3
Safety precautions.....	3
Chapter 1 Functional overview	7
Chapter 2 KEW 2060BT features.....	8
Chapter 3 Basic operation	9
3.1 Function switch.....	9
3.2 Buttons and switches.....	9
3.3 Symbols displayed in LCD.....	11
3.4 Unit of measured value.....	12
Chapter 4 Getting started.....	12
4.1 Turning on KEW 2060BT.....	12
4.2 Battery level check	12
LCD indication/ Battery level indicator	13
How to install batteries:.....	13
4.3 Test leads connection (to KEW 2060BT)	14
4.4 Connection to the measured object	14
Chapter 5 Settings.....	16
Item selection (Switch the displayed items).....	16
Wiring systems	17
VT/ CT ratio	17
Measurement using VT/ CT ratio.....	18
Buzzer ON/ OFF.....	19
Backlight ON/ OFF	19
Frequency of nominal voltage.....	19
System reset	20
Chapter 6 Display items by measurement function.....	21
6.1 RMS/ Frequency measurement.....	21
RMS current, frequency.....	21
RMS voltage, frequency	22
6.2 Single/ Three-phase (balance) Power measurement	23
Connection diagram for Single-phase 2-wire (1P2W).....	23
Connection diagram for Single-phase 3-wire (1P3W).....	23
Connection diagram for balance Three-phase 3-wire (3P3W).....	24
Connection diagram for balance Three -phase 4-wire (3P4W).....	24
Switching display	25
6.3 Three-phase (unbalance) power measurement.....	26
Three-phase 3-wire (3P3W) unbalance.....	26
Three-phase 4-wire (3P4W) unbalance.....	29
6.4 Harmonics measurement	32
Current harmonics distortion factor, content rate, RMS value.....	32
Voltage harmonics distortion factor, content rate, RMS value.....	33
Harmonics distortion factor THD-R/ THD-F	35
6.5 Phase detection	36

Chapter 7 Other functions	37
[Data hold function].....	37
[Auto-backlight-off].....	37
[Auto-power-off].....	37
[Auto-ranging – current].....	37
Chapter 8 Bluetooth communication.....	38
8.1 KEW Power* (asterisk) features	39
Chapter 9 Specifications.....	40
9.1 Safety specifications.....	40
9.2. General specifications	40
9.3 Measurement specifications.....	41
AC current function \tilde{A}	41
AC Voltage function \tilde{V}	42
Power function W	43
Voltage current phase difference (θ) [deg] (at Single-phase 2-wire measurement only)	45
Harmonics function 	46
Phase detection function 	48

Unpacking

We thank you for purchasing our clamp power meter KEW 2060BT.
Please check that the following accessories are packed with the instrument.

[Basic package]

1	Clamp power meter	KEW 2060BT : 1 pce.
2	Test leads	MODEL7290: 1 set * Red, black, and yellow: 1 pce. each with alligator clips
3	Batteries	Alkaline size AA battery (LR6) x 2 pcs.
4	Instruction manual	: 1 pce.
5	Soft case	MODEL9198 : 1 pce.

- In case any of the items listed above are found to be damaged or missing or if the printing is unclear, please contact your local KYORITSU distributor.

Safety precautions

This instrument has been designed, manufactured and tested according to IEC 61010: Safety requirements for Electronic Measuring apparatus, and delivered in the best condition after passing quality control tests.



This instruction manual contains warnings and safety procedures which have to be observed by the user to ensure safe operation of the instrument and to maintain it in safe condition. Therefore, read through these operating instructions before starting to use the instrument.

WARNING







- Read through and understand the instructions contained in this manual before using the instrument.
- Keep the manual at hand to enable quick reference whenever necessary.
- The instrument is to be used only in its intended applications.
- Understand and follow all the safety instructions contained in the manual.

It is essential that the above instructions are adhered to. Failure to follow the above instructions may cause injury, instrument damage and/or damage to equipment under test. Kyoritsu assumes no responsibility for damage and injury caused by misuse or not following the instructions in the manual.

The symbol  indicated on the instrument, means that the user must refer to the related parts in the manual for safe operation of the instrument. It is essential to read the instructions wherever the symbol appears in the manual.

-  DANGER : is reserved for conditions and actions that are likely to cause serious or fatal injury.
-  WARNING : is reserved for conditions and actions that can cause serious or fatal injury.
-  CAUTION : is reserved for conditions and actions that can cause injury or instrument damage.

Meaning of symbols on the instrument:

	User must refer to the explanations in the instruction manual.
	Instrument with double or reinforced insulation
	This instrument can clamp a bare conductor where the voltage to be measured is lower than the circuit – voltage against earth values specified by the marked measurement category.
	AC (Alternating current)
	(Functional) Earth terminal
	This instrument satisfies the marking requirement defined in the WEEE Directive (2002/96/EC). This symbol indicates separate collection for electrical and electronic equipment.

Measurement Category

To ensure safe operation of measuring instruments, IEC 61010 establishes safety standards for various electrical environments, categorized as O to CAT IV, and called measurement categories. Higher-numbered categories correspond to electrical environments with greater momentary energy, so a measuring instrument designed for CAT III environments can endure greater momentary energy than one designed for CAT II.

O : Circuits which are not directly connected to the mains power supply.

CAT II : Electrical circuits of equipment connected to an AC electrical outlet by a power cord.

CAT III : Primary electrical circuits of the equipment connected directly to the distribution panel, and feeders from the distribution panel to outlets.

CAT IV : The circuit from the service drop to the service entrance, and to the power meter and primary overcurrent protection device (distribution panel).

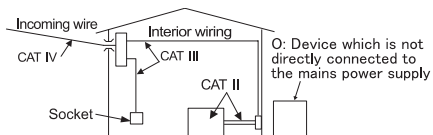

 **DANGER**

- The instrument is to be used only in its intended applications or conditions. Otherwise, safety functions equipped with the instrument will not work, and instrument damage or serious personal injury may occur. Verify proper operation on a known source before taking action as a result of the indication of the instrument.
- Wear protective insulated gears if electrical shock or other danger is possible.
- This instrument is rated to 600 V AC for CAT IV, and 1000 V AC for CAT III. With attention to the measurement category to which the object under test belongs, do not make measurements if voltage against earth in the circuit under test exceeds these values.
- Do not attempt to make measurement in the presence of flammable gasses. Otherwise, the use of the instrument may cause sparking, which can lead to an explosion.
- Never attempt to use the instrument if its surface or your hand is wet.

- Measurement -

- Do not exceed the maximum allowable input of any measuring range.
- Never open the battery compartment cover during a measurement.

- Clamp sensor -

- Confirm that the measured current rating of the circuit under test and the instrument; in addition, don't exceed the rated voltage against earth.
- Keep your fingers behind the barrier during a measurement.
Barrier: provides protection against electrical shock and ensuring the minimum required clearance and creepage distances.
- Connect to the secondary side of a circuit breaker since a current capacity at the primary side is large and dangerous.
- Do not touch two lines under test when opening the jaws.

- Test leads -

- Use only the ones supplied with the instrument.
- When the instrument and the test lead are combined and used together, whichever lower category either of them belongs to will be applied. Confirm that the measured voltage rating of the test lead is not exceeded.
- Connect the cables that are required for the desired measurement only.
- Connect the test leads to the instrument first, and only then connect them to the circuit under test.
- Keep your fingers behind the barrier during a measurement.
Barrier: provides protection against electrical shock and ensuring the minimum required clearance and creepage distances.
- Never disconnect the test leads from the voltage input terminals of the instrument during a measurement (while the instrument is energized).
- Do not touch two lines under test with the metal tips of the test leads.
- Never touch the metal tips of the test leads.

- Battery -

- Do not try to replace the batteries during a measurement.

⚠ WARNING

- Never attempt to make any measurement if any abnormal conditions, such as a broken cover or exposed metal parts are present on the Instrument, or test leads.
- Verify proper operation on a known source before use or taking action as a result of indication of the instrument
- Do not install substitute parts or make any modification to the instrument. Return the instrument to your local KYORITSU distributor for repair or re-calibration in case of suspected faulty operation.

⚠ CAUTION

- Use of this instrument is limited to domestic, commercial and light industry applications. Strong magnetic interference or strong magnetic fields, generated by large currents, may cause malfunction of the instrument.
 - Caution should be taken since conductors under test may be hot.
 - Never apply currents or voltages exceeding the maximum allowable input to each range.
 - Do not apply currents or voltages for the test leads or current sensors while the instrument is off.
 - Don't use the instrument at dusty places or to be spattered.
 - Don't use the instrument under a strong electric storm or in the vicinity of energized object.
 - Never give strong vibrations or drop shocks.
- Test leads -**
- Connect the plug firmly to the corresponding terminal.
 - Do not pull or twist the test leads with excessive force to prevent damage.
- Battery -**
- Brand and type of the batteries should be harmonized.
- Treatment after use -**
- Set the function switch to "OFF" position and remove all the cables from the instrument.
 - Take out batteries if the instrument is to be stored and will not be in use for a long period.
 - Never give strong vibrations or drop shocks when carrying the instrument.
 - Do not expose the instrument to direct sunlight, high temperature, humidity or dew.
 - Use a damp cloth with neutral detergent or water for cleaning the instrument. Do not use abrasives or solvents.
 - If the instrument is wet, dry and store it.

Carefully read and follow the instructions with **⚠ DANGER**, **⚠ WARNING**, **⚠ CAUTION** symbols and NOTE described in each section.

Chapter 1 Functional overview

KEW 2060BT is an advanced clamp power meter that is able to analyze the harmonics for power quality check and verify phase sequences of power sources in various wiring systems: of course, it can perform voltage/ current (in RMS) and power measurements.

KEW 2060BT has Bluetooth communication function to connect itself with Bluetooth devices, like a tablet, for remote monitoring and data saving.

Safety Construction

Designed to meet the international safety standard IEC 61010-1 CAT IV 600 V/ CAT III 1000 V.

Wiring configuration

KEW 2060BT supports: Single-phase 2-wire (Single-phase 3-wire), Three-phase 3-wire (two-wattmeter method), and Three-phase 4-wire.

Large-diameter clamp sensor

The current clamp sensor is able to clamp onto a wire up to 75mm in diameter or a buster up to 80mm width safely.

Measurement and calculation

KEW 2060BT can measure and calculate voltage, current, active/ reactive/ apparent power, power factor, voltage-current phase differences, and frequency. (TRMS display)

Harmonics measurement

It is possible to measure and show each voltage/ current harmonic from 1st to 30th (in RMS.), content rate, and total distortion factor (THD-R/THD-F).

Phase detection

This function is to verify phase rotation and missing phases of power source.

Application

Measured results and waveform data can be transferred to tablet devices or smartphones using Bluetooth. Special application "KEW Power*(asterisk)" is available for reviewing the measured data.

Chapter 2 KEW 2060BT features

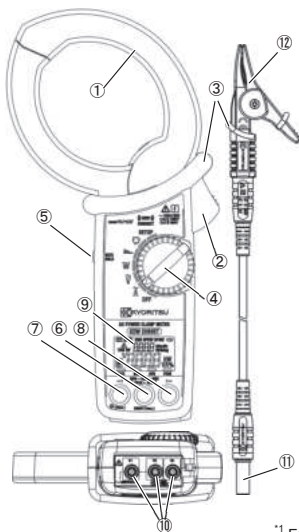

- ① Current sensor
- ② Trigger (to open/ close the jaws)
- ③ Barrier
Provides protection against electrical shock and ensuring the minimum required clearance and creepage distances. Always keep your fingers behind the barrier.
- ④ Function switch
Turn and select the desired measurement function. This switch also works as power switch: set it to "OFF" to turn off the instrument.
- ⑤ Data hold switch
Holds the displayed readings. The LCD shows "H" symbol while the result is being held in the display.
- ⑥ Mode button^{*1, 2}
Toggles the displayed results in the sequences: MAX: maximum value -> MIN: minimum value -> AVG: average value -> |PEAK|: crest factor (absolute value).
- ⑦ Backlight button * (1000) [◀]^{*2}
A long press turns on/ off the backlight.
- ⑦⑧ Item switching button [◀▶]^{*}
A short press toggles displayed items in sequences.





^{*1} Function ranges, related to current measurements, are fixed while the LCD is showing MAX/ MIN/ AVG/ |PEAK| (absolute value). The auto-ranging function is reactivated when switching the display to instantaneous value.

^{*2} Buttons ⑥ to ⑧, ⑦ excluded, work differently depending on the selected measurement function. For further detail, see *clause 3.2 Buttons and switches, P. 9*, and explanations about each function.



- ⑨ LCD
Field effect LCD with backlight
- ⑩ AC voltage input terminal
Connect the plug ⑪ of test lead (M-7290) to the corresponding terminal depending on the wiring configuration to be tested.
- ⑪ Plug
- ⑫ Alligator clip

Chapter 3 Basic operation

3.1 Function switch

Function	Description
SETUP Settings	Changes and confirms the settings for wiring, VT/ CT ratio, buzzer on/ off, backlight on/ off, nominal frequency 50/ 60Hz. To restore all the settings to the default conditions, perform system reset.
 Phase detection	Tests and shows the phase rotation sequence, and missing phase if there is any.
 Harmonics	Shows voltage/ current (of the 1st fundamental waveform up to 30th harmonics) RMS value, content rate, and distortion factor [THD-R/THD-F].
W Power	Shows: active/ reactive/ apparent power, power factor, voltage-current phase differences, and voltage/ current (RMS) value.
 AC voltage	Shows AC voltage RMS value, peak value, and frequency.
 AC current	Shows AC current RMS value, peak value, and frequency.





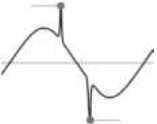

3.2 Buttons and switches

Function	Buttons and switches	Details
---	Data hold button	Hold down the Data hold button until the LCD shows "  " symbol: then the currently displayed value is held. While this function is activated, readings don't change even the input value varies. To exit from the hold mode, press the data hold button again or switch the measurement functions: the "  " symbol disappears.
	Backlight button  [◀]	A long press turns on/ off the backlight.
SETUP	Item switching button [◀▶]	Toggles displayed items and changes the setting values.
	Mode button	Selects setting items and confirms the entered values.
Harmonics	Item switching button [◀▶]	A short press toggles display: <-> THD-F <-> THD-R <-> 1st fundamental wave to 30th harmonics.
	[▶]	A long press switches voltage and current RMS values.
	Mode button	A short press toggles display: <-> Inst value <-> MAX <-> MIN <-> AVG. A long press resets measurements of MAX, MIN, and AVG values and resume a measurement.

Function	Buttons and switches	Details
Power 1P2W 1P3W	Item switching button [◀▶]	A short press toggles display: <-> active power, power factor <-> active power, voltage-current phase differences <-> active and apparent power <-> active and reactive power <-> current and voltage RMS.
	Mode button	A short press toggles display: <-> Inst value <-> MAX <-> MIN <-> AVG. A long press resets measurements of MAX, MIN, and AVG values and resume a measurement.
Power 3P3W 3P4W Balance	Item switching button [◀▶]	A short press toggles display: <-> active power, power factor <-> active and apparent power <-> active and reactive power <-> current and voltage RMS.
	Mode button	A short press toggles display: <-> Inst value <-> MAX <-> MIN <-> AVG. A long press resets measurements of MAX, MIN, and AVG values and resume a measurement.
Power 3P3W Unbalance	Item switching button [▶]	A short press during a measurement: Switches the phase to be measured from R(L1) to T(L3).
	Item switching button [◀▶]	A short press while displaying the measured result: Toggles displays: <-> Three-phase active power <-> R(L1)-phase active power <-> T(L2)-phase active power.
	Mode button	A short press during a measurement: Switches between active power and voltage and current values (RMS). A long press while displaying the measured result: Clears the displayed values and resume a measurement.
Power 3P4W Unbalance	Item switching button [▶]	A short press during a measurement: Switches the phase to be measured: R(L1) -> S(L2) -> T(L3). A short press while displaying the measured result: Toggles displays: <-> active power, power factor <-> active and apparent power <-> active and reactive power.
	Mode button	A short press during a measurement: Switches between active power and voltage and current values (RMS). A long press while displaying the measured result: Clears the displayed values and resume a measurement.

Function	Buttons and switches	Details
~V ~A	Mode button	<p>A short press toggles display: <-> Inst value <-> MAX <-> MIN <-> AVG <-> PEAK (peak value*).</p> <p>A long press resets measurements of MAX, MIN, AVG, and PEAK values and resume a measurement.</p> <p>* PEAK : Shows the instantaneous peak value in absolute value.</p> 

3.3 Symbols displayed in LCD

Symbol	Details
	Battery indicator: shows remaining battery in 4 levels.
	Bluetooth is available.
	LCD display update is held.
UNB	Unbalance measurement has been selected. Nothing is displayed for balance measurement.
3P3W 3P4W	Wiring configuration. No indication for single-phase.
P 1P2	Total power: when "either "P1" or "P2" is displayed, it indicates the power of the single-phase according to the display.
	Buzzer is disabled.
THD R THD F	Type of total harmonics distortion factor.
h- 1	Harmonics order: shows 1st (h-1) fundamental wave to 30th (h-30).
	VT ratio other than 1/1 has been set.
	CT ratio other than 1/1 has been set.
	Appears to indicate the type of measured value.
-	Negative (-) or positive (no symbol) mark is displayed according to the polarity of a measured value. For further detail, please see "9.3 Measurement specifications".

3.4 Unit of measured value

Unit					
V	RMS voltage	A	RMS current	Hz	Frequency
kW	Active power	kVar	Reactive power	kVA	Apparent power
PF	Power factor	deg	V-A phase difference	%	Harmonics content rate

Chapter 4 Getting started

4.1 Turning on KEW 2060BT

Note

- If the instrument is in powered-off state, though the function switch is set to any measurement range, auto-power off function might be activated. Turn the function switch to OFF, and then set the switch to the desired position to wake up the instrument. Even though the instrument doesn't wake up, the installed batteries may be totally exhausted. Please replace the batteries with new ones and try again.





When setting the function switch to any position other than "OFF", KEW 2060BT gets started and all the LCD segments are displayed for 1 sec. Confirm that there're no chips of segments.

4.2 Battery level check

⚠ DANGER

- Never try to replace batteries during a measurement.

⚠ WARNING

- Before opening the battery compartment cover for battery replacement, disconnect all test leads from the instrument and set the function switch to "OFF".
- Do not replace batteries if the instrument is wet.
- Accurate measurement results cannot be obtained while the battery warning indicator  is blinking. Stop using the instrument and replace the batteries with new ones immediately. If the batteries are totally exhausted, the LCD doesn't show anything nor  symbol.

CAUTION

- Brand and type of the batteries should be harmonized.
- Never mix new and old batteries.
- Install batteries in correct polarity as marked inside the battery compartment area.

LCD indication/ Battery level indicator

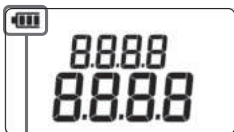

Battery level	Status	Details
		Battery level is full.
		Indicator varies depending on the battery level.
		Battery level is low. Replace the batteries with new ones.
	 Blink	Battery level is extremely low, and the instrument doesn't work normally. Stop using the instrument and replace the batteries with new ones immediately. The instrument continues measurement even in this state; however, Bluetooth will be disabled.

How to install batteries:

Follow the procedures below and insert batteries.

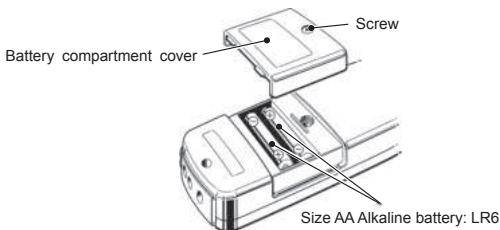

- 1 Disconnect all cables and set the function switch to OFF position.
- 2 Loosen one battery compartment cover-fixing screw and remove the cover.
- 3 Take out all the batteries.
- 4 Insert two new batteries, size AA alkaline: LR6, observing correct polarity.
- 5 Install the cover, and then secure it with the screw.

4.3 Test leads connection (to KEW 2060BT)

! The followings should be checked before the connection.

⚠ DANGER

- Use only the test leads supplied with this instrument.
- Connect the cables that are required for the desired measurement only.
- First, connect the plug of the test lead to the instrument. Only then connect to the measurement line.
- Never disconnect the test lead from the voltage input terminal of the instrument during a measurement (while the instrument is energized).

⚠ WARNING

- Never attempt to make measurement if any abnormal conditions are noted, such as a crack or exposed metal parts.

⚠ CAUTION

- Confirm that the instrument is powered off, and then connect the test leads.
- Connect to the instrument first, firmly into the corresponding terminal.

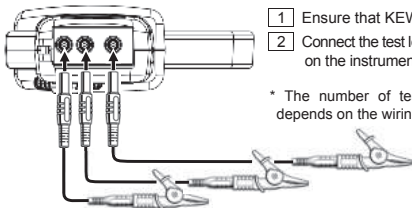

Connect the test leads per the following procedures.

- 1 Ensure that KEW 2060BT is turned off.
- 2 Connect the test lead to AC voltage input terminal on the instrument.*

* The number of test leads to be connected depends on the wiring configuration.

4.4 Connection to the measured object

! The following should be checked before the connection.

⚠ DANGER

- This instrument is rated to 600 V AC for CAT IV, and 1000 V AC for CAT III. With attention to the measurement category to which the object under test belongs, do not make measurements on a circuit in which voltage exceeds these values.
- Use only the test leads designed for this instrument.
- Always connect the test leads to the instrument first.
- When the instrument and the test lead are combined and used together, whichever lower category either of them belongs to will be applied. Pay attention to the rating of the instrument and test lead used together.
- Connect the cables that are required for the desired measurement only.
- Current sensor shall be connected to the secondary side of the circuit breaker since the primary side has dangerous large current capacity.

⚠ DANGER

- Care should be taken so as not to short-circuit the power line with the metal ends of the test lead at connection. In addition, do not touch the metal tips.
 - The tips of the current sensor jaws are designed so as not to short-circuit the power line of the object to be tested but be careful when measuring an un-insulated conductor.
 - Keep your fingers behind the barrier during a measurement.
- Barrier: provides protection against electrical shock and ensuring the minimum required clearance and creepage distances.

! For accurate measurement:

- The declared measurement accuracy is guaranteed where the conductor to be measured is placed at the center of the current clamp sensor.
- Care should be taken so as not to pinch the conductors with the tips of the jaws.
- Confirm and harmonize the wiring configuration of the measurement line and KEW 2060BT.
- When clamping onto a conductor, make the arrow mark point towards the load side; otherwise, polarity of active power (P) will be reversed and displayed.

- Never clamp two or more conductors.

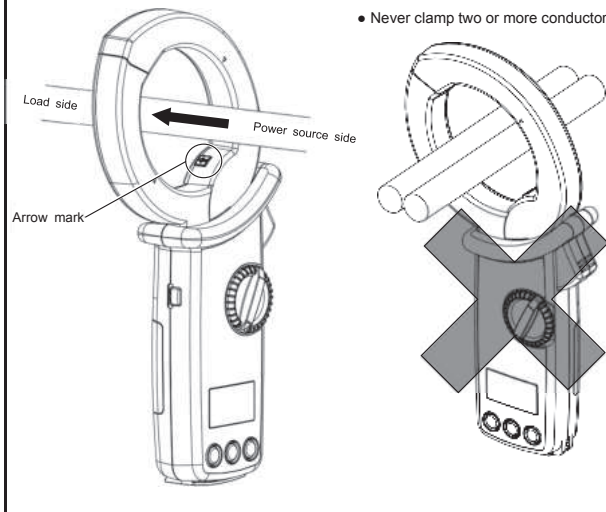

Chapter 5 Settings

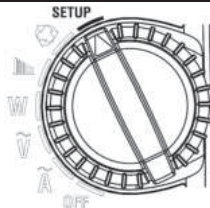

Before starting a measurement, adjust the following settings.
 * Wiring configuration, frequency of the voltage to be measured, and VT/ CT ratio, if necessary.

Set the function switch to "**SETUP**" to adjust settings.

Note

- Turning the function switch before confirming the altered settings clears all the changes you made. Confirm the altered settings, and then turn the function switch.

Item selection (Switch the displayed items)

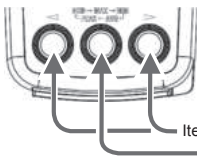

Press the item switching button [◀▶] to toggle the displayed items and confirm the desired item with the mode button. Alter the values of each item with the item switching button [◀▶], and then press the mode button again to confirm the change. The display returns to the selection screen.

Item switching button [◀▶]: toggles setting items
 Mode button : confirms selection and change.

The followings are the default settings. System reset restores the altered changes to the default.

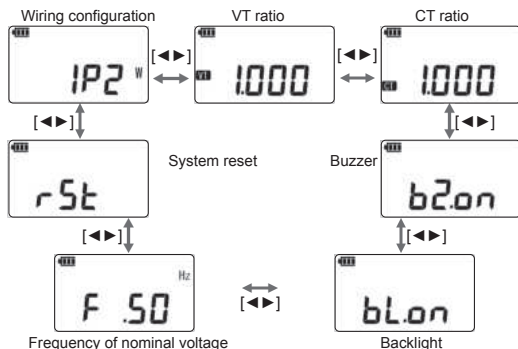

Wiring systems

Select "Wiring configuration" and press the mode button to adjust wiring configurations. Select the appropriate one out of five wiring configurations according to the wiring system to be tested.

* For Single-phase 3-wire(1P3W), please select "1P2W" (Single-phase 2-wire) and perform power measurement on each phase (L1/ L2) individually. KEW 2060BT cannot show the total power of 1P3W.

Item switching button [$\leftarrow\rightarrow$]: toggle the available wiring configurations

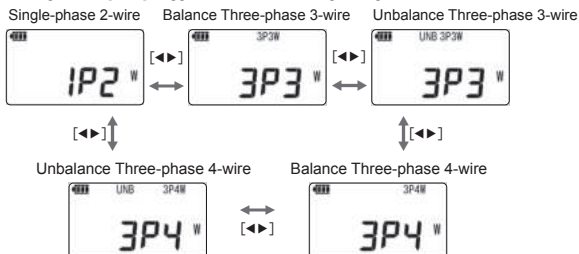

Press the mode button while the desired wiring configuration is displayed. The selection is confirmed and the display returns to the selection screen.

VT/ CT ratio

CAUTION

- The display range, when setting VT or CT ratio, is between 0.000 and 9999 (RMS voltage/current) and between 0.000k and 9999k (power). Please take the display range into consideration when setting VT or CT ratio. If setting extremely large or small VT or CT ratio, the LCD may show 0 or OL and wouldn't change.
- Allowable input is 1100 V to AC voltage terminal and 1100 A to current sensor, regardless of selected VT or CT ratio. If output of the connected VT or CT exceeds these values, the LCD shows OL.

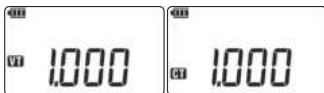

This setting is required if the system to be tested has external VT(s) or CT(s). The set VT/ CT ratio will be reflected to all the values measured during any measurements related to voltage and current.

While the LCD is showing VT or CT ratio, press the mode button. Then 4-digit value is displayed and the changeable digit starts blinking. Selectable range is between 0.001 and 9999.



The digit selected to be changed will blink.

A short press of item switching button [◀▶] increases or decreases the value by 1. A long press of the item switching button changes digit position (to right or left). When pressing the button, while the last digit is blinking, not a digit position but a decimal point moves. A long press of mode button while changing values or digit position cancels the changes and restores the setting to 1.000.

Press the mode button to confirm the changes. The display returns to the selection screen.

Measurement using VT/ CT ratio

⚠ DANGER

- This instrument is rated to 600 V AC for CAT IV, and 1000 V AC for CAT III. With attention to the measurement category to which the object under test belongs, do not make measurements on a circuit in which the electrical potential exceeds these values.
- Always clamp the secondary side of VT or CT (transformer).
- Do not open-circuit the secondary side of CT while it is energized; otherwise, dangerous high voltage will be generated at the secondary side.

⚠ CAUTION

- When using a VT or CT, the declared measurement accuracy is not guaranteed. If using either or both of them, please take the accuracies of KEW 2060BT, VT and CT, and also phase characteristics into consideration.

If voltage or current values of the measurement line exceed the max measuring range of KEW 2060BT, the primary side value of the line can be obtained by measuring the secondary side using proper VT or CT for the specific line's voltage or current. See the diagram below.

Example:

Single-phase 2-wire (1P2W)

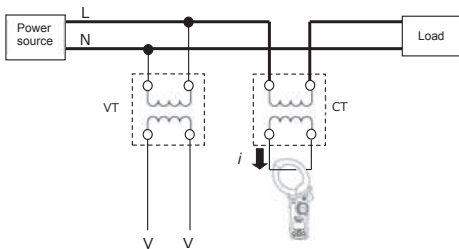

Buzzer ON/ OFF

Keypad sounds, and phase detection buzzer can be muted. This setting doesn't affect the low battery warning buzzer and the buzzer indicating auto-power-off is activated.

Select "Buzzer" and press the mode button. Then "ON(on)"/ "OFF(oF) starts blinking. Now it is ready to change the setting.

Item switching button [$\blacktriangleleft\blacktriangleright$]:

on: Buzzer sounds

oF: No buzzer sounds



Press the mode button to confirm the changes. The display returns to the selection screen.

Backlight ON/ OFF

This setting is to enable or disable auto-backlight-off function if there're no key operations for the specified time.

Select "Backlight" and press the mode button. Then "ON(on)"/ "OFF(oF) starts blinking and now it is ready to change the setting.

Item switching button [$\blacktriangleleft\blacktriangleright$]:

on: Turns off in 5 min.

oF: Disables auto-off function.

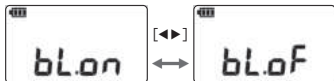

Press the mode button to confirm the changes. The display returns to the selection screen.

Frequency of nominal voltage

Set the power frequency of the object to be measured.

Note

- Harmonics are calculated based on the preset frequencies. For accurate measurement, please check and set the same frequency as the power frequency of the object to be tested.

Select "Frequency of nominal voltage" and press the mode button. Then ".50[Hz]"/ ".60[Hz]" starts blinking; that means it is ready to change the setting.

Item switching button [$\blacktriangleleft\blacktriangleright$]: Switches the frequencies.



Press the mode button to confirm the changes. The display returns to the selection screen.

System reset

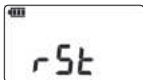

Restore all the settings to default*. *See P.16 Item selection part.
Select "System reset" and press the mode button. Then "n: Cancel" starts blinking; that means it is ready to change the setting.

Item switching button [◀▶]:

.n: Cancel

.y: Performs system reset.



Select ".y" and press the mode button. Then system reset will be done and the display returns to the selection screen. To cancel or do not want to do system reset, select ".n" and press the mode button.

Chapter 6 Display items by measurement function

6.1 RMS/ Frequency measurement

While viewing "Waveform" on your Smartphone or tablet device using our app via Bluetooth, KEW 2060BT's LCD will be like the illustration shown to the right and won't show the measured values.

To check the measured values on the instrument, switch the item on your Bluetooth device using the app from "Waveform" to "Measured value", or disconnect Bluetooth communication.



RMS current, frequency

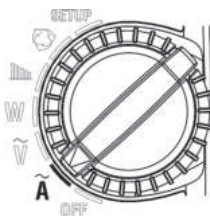

Set the function switch to " \tilde{A} ".

Auto-ranging function activates and switches the current range depending on the measured value.

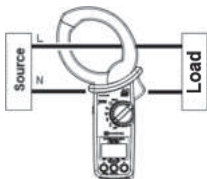

A short press of Mode button: switches display modes between Inst, MAX, MIN, AVG, and |PEAK|.

* Each of above values is determined after pressing the mode button and measurements get started.

A long press of Mode button: clears measured values (MAX, MIN, AVG, and |PEAK|).

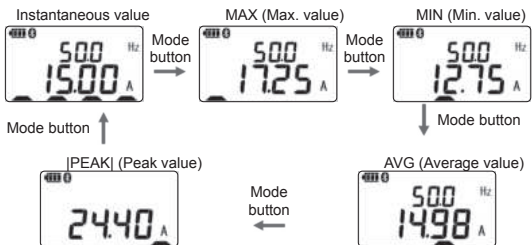

Range is fixed while the LCD is showing MAX, MIN, AVG, or |PEAK|. The auto-ranging function is reactivated when switching the display to instantaneous value.

RMS voltage, frequency

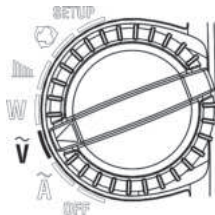

Set the function switch to " \tilde{V} ".

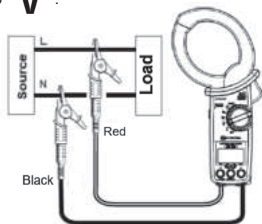

A shot press of Mode button: switches display modes between Inst, MAX, MIN, AVG, and |PEAK|.

* Each of above values is determined after pressing the mode button and measurements get started.

A long press of Mode button: clears measured values (MAX, MIN, AVG, and |PEAK|).

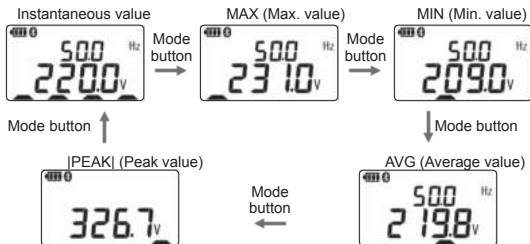

6.2 Single/ Three-phase (balance) Power measurement

Note

- KEW 2060BT cannot measure Three-phase 4-wire with different capacitors (V/Δ -connection). To measure such a system, please test phases individually.

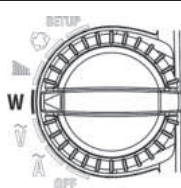

Set the function switch to "W".

Select wiring system in the selection screen.

Single-phase 2-wire (1P2W) Three-phase 3-wire (3P3W) Three-phase 4-wire (3P4W)



Connection diagram for Single-phase 2-wire (1P2W)

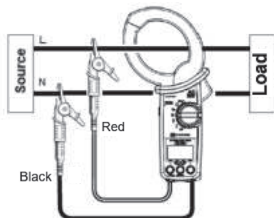

Connection diagram for Single-phase 3-wire (1P3W)

To measure Single-phase 3-wire (1P3W), select "1P2W" and measure power of L1 and L2 separately. KEW 2060BT cannot show the total power of 1P3W.

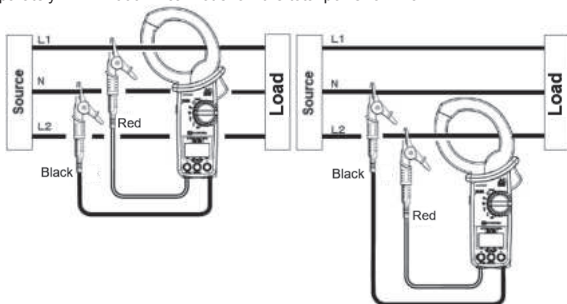

Connection diagram for balance Three-phase 3-wire (3P3W)

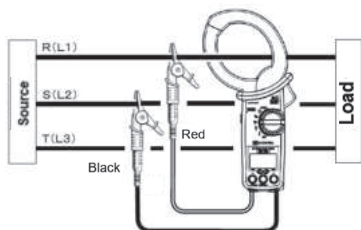

Connection diagram for balance Three-phase 4-wire (3P4W)

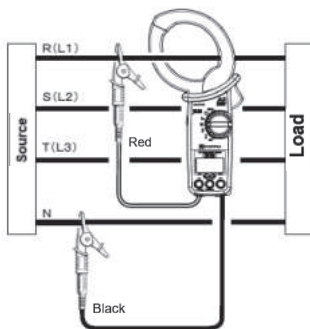

Switching display

Item switching button [$\blacktriangleleft\blacktriangleright$]:

Short press: switches measured values to be displayed in the LCD.

Active power, power factor/ Active power, voltage-current phase difference/ Active, apparent powers/ Active, reactive powers/ RMS current, voltage values

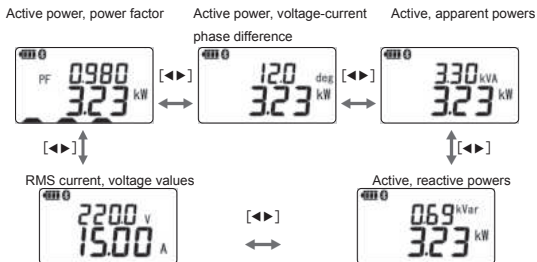

Mode button

Short press: switches display modes between Inst, MAX, MIN, and AVG.

* Each of above values is determined after pressing the mode button and measurements get started.

Long press: clears measured values (MAX, MIN, and AVG)

Example: Active power, power factor* screen

* Measured values displayed in the upper and lower rows are switched together.

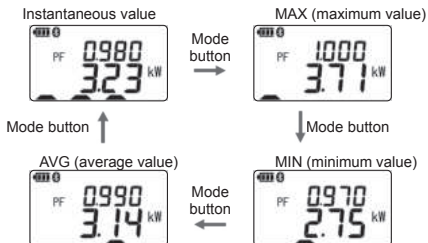

Range is fixed while the LCD is showing MAX, MIN, or AVG. The auto-ranging function is reactivated when switching the display to instantaneous value.

6.3 Three-phase (unbalance) power measurement

Note

- KEW 2060BT cannot measure Three-phase 4-wire with different capacitors (V/ Δ -connection). To measure such a system, please test phases individually.

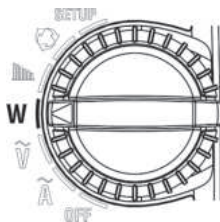

Set the function switch to "W".

Select wiring system in the selection screen.

Three-phase 3-wire (3P3W) Three-phase 4-wire (3P4W)

Unbalance



Unbalance

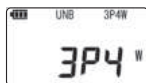

Three-phase 3-wire (3P3W) unbalance

Measurement procedures

Clamp onto R(L1) phase

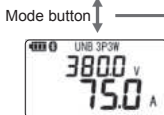
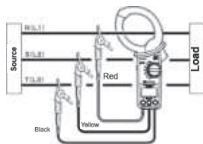

Clamp onto T(L3) phase

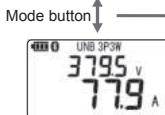
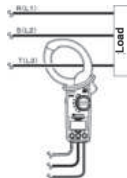
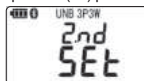

Result display [◀▶]

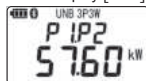

Clamp onto R(L1) phase

While the LCD is showing the settings for the first measurement, make connection as the following figure shows.



Press the item switching button [▶] after making connection, the LCD shows active power of R(L1) phase. Pressing mode button switches the indication between active power and RMS voltage/ current values of R(L1) phase.

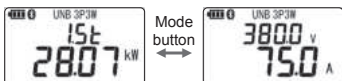
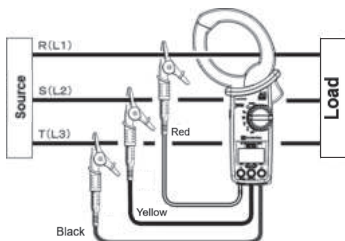

Another press of item switching button [▶] changes measurement object from R(L1) to T(L3).

Clamp onto T(L3) phase

While the LCD is showing the 2nd time measurement screen, switch the current sensor position as shown to the right; just the sensor only, do not unclip or change the position of test leads.

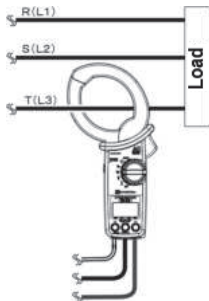

Press the item switching button [▶] after making connection, the LCD shows active power of T(L3) phase. Pressing mode button switches the indications between active power and RMS voltage/ current values of T(L3) phase.

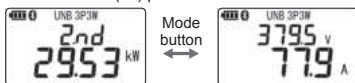

Another press of item switching button [▶] switches the screens to measurement result.

Result display

Item switching button [$\blacktriangleleft\blacktriangleright$]:

Short press: switches measured values to be displayed in the LCD.



A long press of mode button clears measured results and the screen returns to the initial screen.

Three-phase 4-wire (3P4W) unbalance

Measurement procedures

Clamp onto R(L1) phase

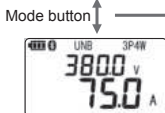
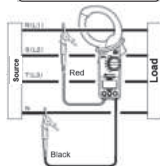

Clamp onto S(L2) phase

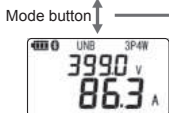
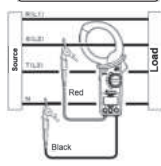
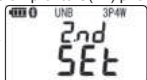

Clamp onto T(L3) phase

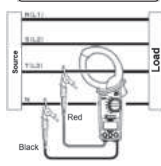
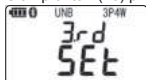

Result display

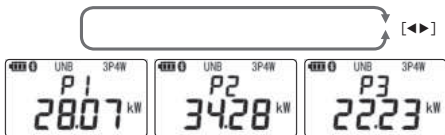

Clamp onto R(L1) phase

While the LCD is showing the 1st time measurement screen, make connection as the following figure shows.

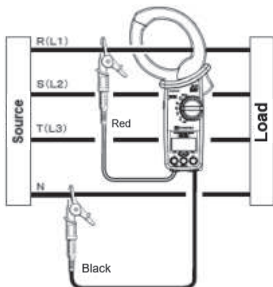

Press the item switching button [▶] after making connection, the LCD shows active power of R(L1) phase. Pressing mode button switches the indication between active power of R(L1) phase and RMS voltage/ current values.



Mode
button
↔



Another press of item switching button [▶] changes measurement object from R(L1) to S(L2).

Clamp onto S(L2) phase

While the LCD is showing the settings for 2nd measurement, make connection as the following figure shows: move the current sensor and red test lead to S(L2) phase.

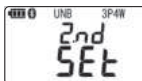

Press the item switching button [▶] after making connection, the LCD shows active power of S(L2) phase. Pressing mode button switches the indication between active power of S(L2) phase and RMS voltage/ current values.

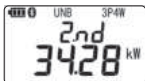
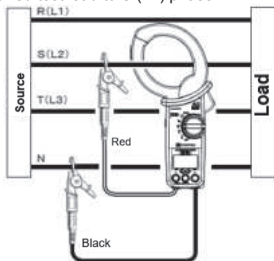

Mode
button
↔



Another press of item switching button [▶] changes measurement object from S(L2) to T(L3).

Clamp onto T(L3) phase

While the LCD is showing the 3rd time measurement screen, move the current sensor and red test lead to T(L3) as shown to the right.

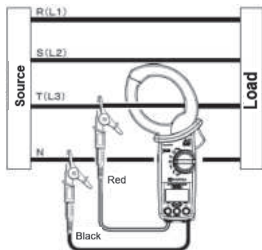
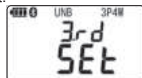

Press the item switching button [▶] after making connection, the LCD shows active power of T(L3) phase. Pressing mode button switches the indication to RMS voltage/ current values of T(L3) phase.

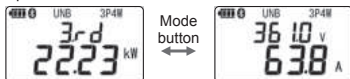

Another press of item switching button [▶] switches the screens to measurement result.

Result display

Item switching button [◀▶]:

Short press: switches measured values to be displayed in the LCD.

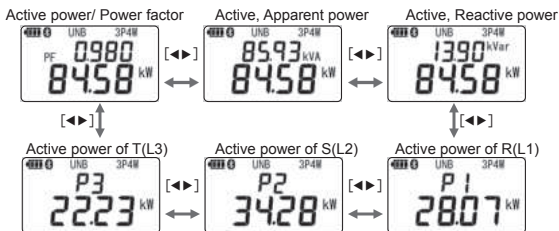

A long press of mode button clears measured results and the screen returns to the initial measurement setting screen.

6.4 Harmonics measurement

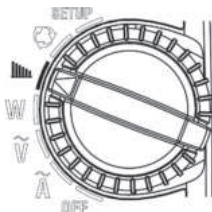

Set the function switch to "  ".

The LCD screen will be as the right figure shows during Bluetooth communication: no measured values are displayed. The measured values can be checked by using the application on your smartphone or tablet device, or by disconnecting the Bluetooth.



Current harmonics distortion factor, content rate, RMS value

Current measurement ranges switches automatically depending on the measured value.

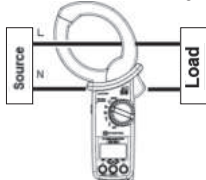

When the unit shown in the LCD is "V", it means the screen is "voltage harmonics measurement screen". Hold down (long press) the Item switching button [▶] to switch the unit to "A".



[Item switching button [◀▶]]

A short press toggles the displayed measured values:

RMS/ Harmonics distortion factor THD-F, RMS/ Harmonics distortion factor THD-R,
1st fundamental wave RMS/ content rate to 30th harmonics RMS/ content rate

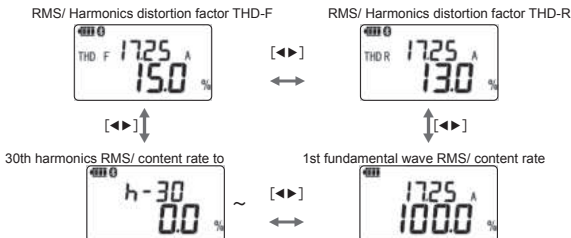

The upper row shows the order of the harmonics (1h to 30h) and RMS of each harmonics: these two switches every second.

[Mode button]

A short press switches display mode between Inst, MAX, MIN, and AVG.

Each of above values is determined after pressing the mode button and measurements get started.

A long press of the button clears measured values (MAX, MIN, and AVG).

Example: Display screen of RMS/ Harmonics distortion factor THD-F*

* Measured values displayed in the upper and lower rows switch simultaneously in every screen.

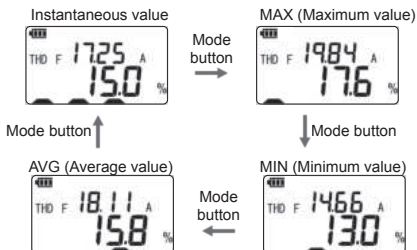

Range is fixed while the LCD is showing MAX, MIN, or AVG. The auto-ranging function is reactivated when switching the display to instantaneous value.

Voltage harmonics distortion factor, content rate, RMS value

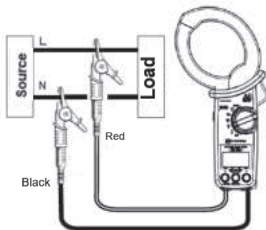

When the unit shown in the LCD is "A", it means the screen is "current harmonics measurement screen". Hold down (long press) the Item switching button [▶] to switch the unit to "V".

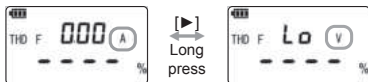

[Item switching button [◀▶]]

A short press toggles the displayed measured values:

RMS/ Harmonics distortion factor THD-F, RMS/ Harmonics distortion factor THD-R,
Fundamental wave RMS/ content rate to 30th harmonics RMS/ content rate

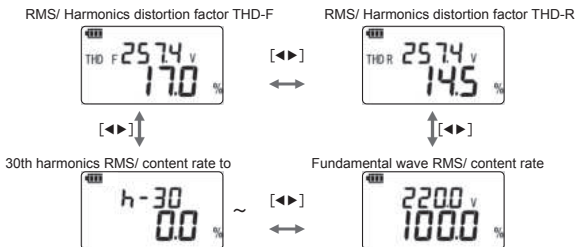

The upper row shows the order of the harmonics (1h to 30h) and RMS of each harmonics: these two switches every second.

[Mode button]

A short press switches display mode between Inst, MAX, MIN, and AVG.

Each of above values is determined after pressing the mode button and measurements get

A long press of the button clears measured values (MAX, MIN, and AVG).

Example: Display screen of RMS/ Harmonics distortion factor THD-F*

* Measured values displayed in the upper and lower rows switch simultaneously in every screen.

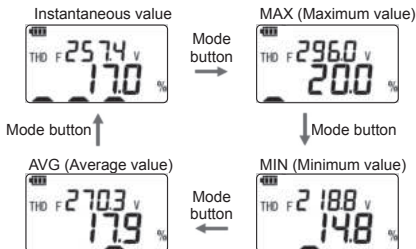

Harmonics distortion factor THD-R/ THD-F

There are two typical definitions used when dealing with Total Harmonic Distortion (THD). The two types of Total Harmonic Distortion are THD-F and THD-R. THD-F uses fundamental wave forms and THD-R uses total RMS values as a reference.

$$\text{THD-F}_{\%} = \frac{\text{RMS harmonics (2nd to...)}}{\text{Fundamental RMS value(1st)}} \times 100$$

$$\text{THD-R}_{\%} = \frac{\text{RMS harmonics (2nd to...)}}{\text{Fundamental RMS value+ RMS harmonics}} \times 100$$

They both are figures of merit used to quantify harmonic levels in voltage and current waveforms; however, the THD-R measurement can be prone to misinterpretation which can easily lead to measurement errors when measuring larger distortions. That is, at low distortion levels, the difference between the two calculation methods - THD-F and THD-R - is negligible but at large distortion levels, THD-F can get more accurate results.

With the former measuring devices, accurate measurement of RMS fundamental wave (first order only), which is required for THD-F calculation had been difficult; therefore, THD-R has been commonly used. Although, recent devices can measure it accurately. So now in practice, THD-R is used for simple measurements and the distortion factor of THD-F, less susceptible to harmonics content rate against specified measurement accuracy, is commonly used.

Where investigating what causes harmonics on load side, THD-R measurement is often used, and for power quality control purpose, the THD-F is mainly used.

6.5 Phase detection

Note

- KEW 2060BT cannot measure Three-phase 4-wire with different capacitors (V/ Δ -connection).
- When setting the buzzer to "OFF", buzzer doesn't sound at the end of detection process. If buzzer indication is required for phase detection judgement, set the buzzer to "ON".

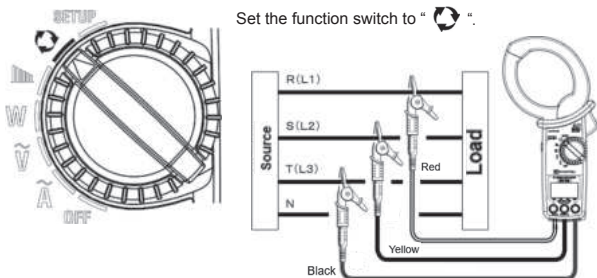

According to the wiring system of Three-phase 3-wire and Three-phase 4-wire to be tested, the results are displayed as the following table shows. Each number represents the connected phase order.

Wiring system				Judgement	
	R(L1)	S(L2)	T(L3)	Indication	Buzzer
Positive phase	Live	Live/ Earth	Live	1.2.3	Discontinuous: Pi, Pi, Pi
Negative phase				3.2.1	Continuous: Piii
Unjudgeable	Missing phase, abnormal frequency, out of voltage effective input range, unbalance			---	Not sound.

Chapter 7 Other functions

[Data hold function]

The LCD shows “H” in the upper left corner by pressing data hold button and hold the currently displayed reading. In this state, the instrument is performing measurements; however, the reading isn't updated. Press the Data hold button again to exit from the data hold mode, then reading update resumes and the “H” disappears.

By switching the measurement function, data hold is disabled, and measurement starts on the selected function.

[Auto-backlight-off]

Backlight turns off automatically when 5 min. pass after the last key operation. To turn it on again, hold down (long press) the Item switching button [◀]. Then the lighting time will be extended 5 min. A long press of Item switching button [◀], while the light is on, turns off the light. When setting the backlight to OFF, written in page 19, the auto-off function is disabled. In this state, backlight doesn't turn off when 5 min pass. To turn off the light, in this case, hold down the Item switching button [◀].

[Auto-power-off]

Note

- If the instrument is off with the function switch set to a measurement position, auto-power-off function might activate and turn off the instrument.

Except for Bluetooth communication, the instrument turns off automatically when 15 min. pass after the last key operation; discontinuous buzzer sounds 4 times. To turn on the instrument again, set the function switch to OFF and then set it to the desired measurement position.

[Auto-ranging – current]

Current range switches automatically according to the measured rms currents.

A range shifts to one upper range when the input exceeds 110% or 300% peak (absolute value) of the currently selected range and shifts to one lower range when the input drops 90% rms. While “MAX”, “MIN”, “AVG”, and “|PEAK| (peak value)” has been selected in the display mode, auto-ranging doesn't work: the selected range is fixed and used.

Chapter 8 Bluetooth communication

WARNING

- Radio waves at Bluetooth communication may affect the operations of medical electronic devices. Special care should be taken when using Bluetooth connection in the areas where such devices are present.

Note

- Using the instrument or tablet devices near wireless LAN devices (IEEE802.11.b/g) may cause radio interferences, lowering of communication speed, resulting in significant time lag in the display update rate between the instrument and tablet device. In this case, keep the instrument and the tablet device away from the wireless LAN devices, or turn off the wireless LAN devices or shorten the distance between the instrument and the tablet device.
- It may be difficult to establish communication connection if either the instrument or tablet device is in a metal box. In such a case, change the measurement location or remove the metal obstacle between the instrument and the tablet device.
- If any leaking of data or information occurs while making a communication using Bluetooth function, we assume no responsibility for any released content.
- Some tablet devices, even if the application runs properly, may fail to establish communication with the instrument. Please use another tablet device and try to communicate with. If you still cannot confirm the connection, there may be some problem with the instrument unit. Please contact your local KYORITSU distributor.
- The Bluetooth word mark and logos are owned by Bluetooth SIG, Inc. and we, KYORITSU, are licensed by them for use.
- Android, Google Play Store, and Google Map are the trademark or registered trademark of Google Inc.
- iOS is the trademark or registered trademark of Cisco.
- Apple Store is the service mark of Apple Inc.
- In this manual, the "TM" and "®" marks are omitted.

This instrument has a Bluetooth communication function and can exchange data with Android/iOS tablet devices. Using the special application "KEW Power*(asterisk)" enables remote monitoring/ checking data.

First, download the application "KEW Power*(asterisk)" via the internet. Some functions are available only while connected to the internet. For further detail, please refer to "8.1. KEW Power*(asterisk) features".

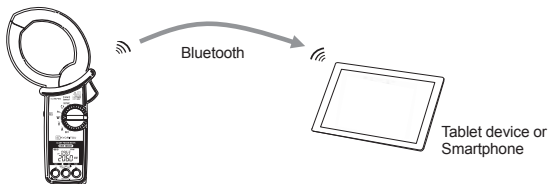

8.1 KEW Power*(asterisk) features

KEW Power*(asterisk) for KEW 2060BT

The special application "KEW Power*" is available on download site for free. (An Internet access is required: Android tablets, via Google Play Store and iOS devices, via App Store). Please note that communication charge is incurred separately for downloading applications and using special features of them. For your information, "KEW Power*" is provided on-line only.

Main features of KEW Power*:



- (1) Remote monitoring/ checking
- (2) Data save/ recall function
- (3) Input wave form display of voltage and current
- (4) Graphical display of harmonics rms values and content rate
- (5) Pass/ fail judgement of measured value

Chapter. 9 Specifications

9.1 Safety specifications

Location for use	: Altitude 2000 m or less, in-door use
Accuracy guaranteed	
Temp. & Hum. range	: 23°C±5°C, Relative humidity 85% or less (no condensation)
Operating Temp. & humidity range	: -10°C to +50°C, 85 % or less (no condensation)
Storage Temp. & humidity range	: -20°C to +60°C, 85 % or less (no condensation)
Withstand voltage	: 7000 V AC/ 5 sec. (between current sensor and enclosure or electrical circuit and enclosure)
Insulation resistance	: 50 MΩ or more/ 1000 V (between electrical circuit and enclosure)
Applicable standards	: • IEC 61010-1, -2-032 (main unit)/ -031 (test leads) Measurement CAT IV 600 V/ CAT III 1000 V Pollution degree 2, • IEC 61326(EMC) Class B, EN50581 (RoHS), • EN 301 489-1, EN 300 328, EN 62479, and • IEC 60529 IP40

9.2. General specifications

Readings update rate	: Approx. 0.5 sec. on A , V , W , and  functions, Approx. 1.0 sec. on  function
Max. conductor size	: ø75 mm (max) and busbar of 80 × 30 mm or less
Dimension	: 283(L) × 143(W) × 50(D) mm
Weight	: Approx. 590g (including batteries)
Accessories	: Test lead MODEL 7290 / alligator clip (red, black, yellow),..... 1 set Instruction manual..... 1 pce. Alkaline size AA battery (LR6)..... 2 pcs. Soft case MODEL9198 1 pce.
Continuous operating time	: Approx. 58 hours (W function, continuous measurement, no load, backlight off, using alkaline size AA (LR6) batteries)
Current consumption	: 35 mA typ. (@3.0 V, W function)
Communication	: Bluetooth® Ver5.0

9.3 Measurement specifications

AC current function \tilde{A}

RMS AC current value (ACA) [Arms], Peak value (Absolute value) [A]peak]

Range	40.00 A / 400.0 A / 1000 A * Auto-ranging, range won't be fixed. A range shifts to one upper range when the input exceeds 110% or 300% peak (absolute value) of the currently selected range and shifts to one lower range when the input drops 90% rms. Where any of "MAX", "MIN", "AVG", or PEAK (peak value) has been selected in the display mode, the selected range is fixed.
Display digit	4-digit
Sampling period	1 cycle / 500ms
Sampling frequency	32.8 kHz (30.5 μ s interval) PEAK value: moving average is 9 points between 40.0Hz and 70.0Hz only.
Effective input range	40.00A range RMS: 0.60 A to 40.00 A, PEAK value: $\pm(0.6 \text{ A to } 56.57 \text{ A})$ 400.0A range RMS: 6.0 A to 400.0 A, PEAK value: $\pm(6.0 \text{ A to } 565.7 \text{ A})$ 1000A range RMS: 60 A to 999.9 A, PEAK value: $\pm(60 \text{ A to } 1414 \text{ A})$
Display range	RMS value: 40.00A range :0.30 to 44.00 A 400.0A range :3.0 (36.0 A*) to 440.0 A 1000A range :30 (360 A) to 1100 A * While auto-ranging is enabled, values displayed with "()" will be effective, and the LCD shows "0" when the input is less than 0.30 A and "OL" when 1100 A is exceeded. PEAK value (absolute value): 40.00A range : 0.30 A to 120.00 A 400.0A range : 3.0 A to 1200.0 A 1000A range : 30 A to 1500 A
Crest factor	3 or less on 40.00A/400.0A range, 3 or less 1500 A peak on 1000A range
Accuracy	RMS: (sine wave) 40.0 to 70.0 Hz: $\pm 1.0\% \text{rdg} \pm 3 \text{dgt}$ 70.1 to 1 kHz: $\pm 2.0\% \text{rdg} \pm 5 \text{dgt}$ * Add $\pm 0.5\% \text{rdg} \pm 5 \text{dgt}$ to the accuracy for sine waves other than 40 to 70 Hz. PEAK value (absolute value): 40.0 to 70.0 Hz: $\pm 2.5\% \text{rdg} \pm 5 \text{dgt}$ 70.1 to 1 kHz: $\pm 4.0\% \text{rdg} \pm 5 \text{dgt}$
Formula	$A = \sqrt{\frac{1}{n} \left(\sum_{i=0}^{n-1} (A_i)^2 \right)}$ i : Sampling point No. n : Number of samples / cycle

Current frequency (Af) [Hz]

Display digit	4-digit
Accuracy	$\pm 0.3\% \text{rdg} \pm 3 \text{dgt}$ (40.0Hz to 999.9Hz, A Range 2.5% to 110%, sine wave)
Display range	40.0 to 999.9Hz

AC Voltage function \tilde{V} RMS AC voltage value (ACV) [Vrms], Peak value (Absolute value) [V|peak|]

Range	1000V
Display digit	4-digit
Sampling period	One cycle/ 500 ms
Sampling frequency	32.8 kHz (every 30.5 μ s) PEAK value: moving average is 9 points between 40.0Hz and 70.0Hz only.
Effective input range	RMS: 30.0 V to 999.9 V Peak value: $\pm(30.0 \text{ V to } 1414 \text{ V})$
Display range	RMS: 30.0 V to 1100 V Peak value (absolute value): 30.0 V to 1555 V * The LCD shows "Lo" when readings are below the lower limit and "OL" when over the upper limit.
Crest factor	1.7 or less
Accuracy	RMS: sine wave 40.0 to 70.0 Hz: $\pm 0.7\% \text{rdg} \pm 3 \text{dgt}$ 70.1 to 1 kHz: $\pm 3.0\% \text{rdg} \pm 5 \text{dgt}$ * Add $\pm 0.5\% \text{rdg} \pm 5 \text{dgt}$ to the accuracy for sine waves other than 40 to 70 Hz. PEAK value (absolute value): 40.0 to 70.0 Hz: $\pm 2.5\% \text{rdg} \pm 5 \text{dgt}$ 70.1 to 1 kHz: $\pm 4.0\% \text{rdg} \pm 5 \text{dgt}$
Input impedance	Approx. 4 M Ω * resistance value across the terminals
Formula	$V = \sqrt{\frac{1}{n} \sum_{i=0}^{n-1} (V_{1i})^2}$ <p>Connect and measure $L=V_1$, $N=V_3$ i : Sampling point No. n : Number of samples/ cycle</p>

Voltage frequency (Vf) [Hz]

Display digit	4-digit
Accuracy	$\pm 0.3\% \text{rdg} \pm 3 \text{dgt}$ *within sine wave of 40.0Hz to 999.9Hz, ACV and ACA effective input range (40.0 Hz to 999.9 Hz, 25 V to 1100 V, sine wave)
Display range	40.0 to 999.9 Hz The LCD shows "----" when readings are out of the display range or display range of ACV and ACA).
Signal source	V_1 to V_3 (voltage across terminals) or A

Power function **W**

Active power (P) [W]

Range	40.00kW/400.0 kW/1000 kW * Switched according to the selected current range.	
Display digit	4-digit (The LCD shows "----" if the reading is out of the guaranteed accuracy range.)	
Sampling period	1 cycle/ 500ms	
Sampling frequency	32.8 kHz(30.5 μs interval)	
Effective input range	Effective input range of RMS voltage, and RMS current and within the frequency range of 45 to 65 Hz.	
Display range	40.00kW range : 0.00 to 44.00 kW 400.0kW range : 0.0 (36.0 kW) to 440.0 kW 1000kW range : 0 (360 kW) to 1210 kW * Currently selected range is fixed if you select MAX, MIN, or AVG in display mode. * Values within parenthesis will be displayed while auto-ranging function is activated, and "----" will be displayed when readings are out of the display range of RMS voltage or RMS current and effective input frequency.	
Accuracy	For sine wave with power factor 1 : ±1.7%rdg±5dgt influence of phase angle within ±3.0° where: within the effective input range for ACV and ACA functions, PF: 1, sine wave, and 45 – 65 Hz) * Sum value: Total errors determined by each measurement channels. (doubled: 3P3W, tripled: 3P4W)	
Polarity sign	Consumption (flow-in): no sign, Regeneration(flow-out): -	
Formula	$P = \frac{1}{n} \left(\sum_{i=0}^{n-1} (V_i \times A_i) \right)$	V is used as reference, i : Sampling point No. n : Number of samples/ cycle
Wiring system	Display value	Destination
1P2W·1P3W	P	1P2W:L=V1·A ,N=V3 1P3W: L1/L2=V1·A, N=V3
Balance 3P3W	Psum(=Ssum×cos(θ))	R=V1·A, S=V3
Balance 3P4W	Psum(=P×3)	R=V1·A, N=V3
Unbalance 3P3W	P1, P2 ,Psum(=P1+P2)	P1 :R=V1·A, S=V2, T=V3 P2 :R=V1 ,S=V2, T=V3·A * Change the connected points twice and test (2-wattmeter method)
Unbalance 3P4W	Displayed only when measuring each phase: P1, P2, P3 Total value: Psum(=P1+P2+P3)	P1: R=V1·A, N=V3 P2: S=V1·A, N=V3 P3: T=V1·A, N=V3 * Change the connected points three times and test

Apparent power (S) [VA]

Range	Same as the active power	
Display digit	Same as the active power	
Effective input range	Same as the active power	
Accuracy	±1dgt to the result determined by each measured value * Sum: add errors of each channel, 3P3W: ±2dgt, 3P4W: ±3dgt	
Polarity sign	No sign	
Formula	$S=V \times A$ * When $P > S$, $P=S$.	
Wiring system	Display value	Destination
1P2W·1P3W	S	Same as the active power
3P3W (balance)	$S_{sum}(=S \times \sqrt{3})$	
3P4W (balance)	$S_{sum}(=S \times 3)$	
3P4W (unbalance)	$S_{sum}(=S_1+S_2+S_3)$ * S_n : Apparent power at the nth measurement	

Reactive power (Q) [Var]

Range	Same as the active power	
Display digit	Same as the active power	
Effective input range	Same as the active power	
Accuracy	±1dgt to the result determined by each measured value * ±2dgt when measuring balance 3P3W, ±3dgt when measuring balance 3P4W	
Polarity sign	Phase delay: no sign, Phase advance: -	
Formula	$Q=\sqrt{S^2 - P^2}$ * Where $P > S$, $P=S$. * $Q=0$ when $ P > S$. * Polarity symbol is displayed depending on the current phase angle with the voltage phase (0°) as reference. See the followings. 0° to -90° to 180° : No sign (+) Phase delay 0° to $+90^\circ$ to 180° : Negative (-) Phase advance * When $ P > S$, $Q=0$. * Polarity symbol is displayed depending on the voltage-current phase difference (θ). 0° to -90° to 180° : No sign (+) Phase delay 0° to $+90^\circ$ to 180° : Negative (-) Phase advance	
Wiring system	Display value	Destination
1P2W·1P3W	Q	Same as the active power
3P3W (balance)	$Q_{sum}(=\sqrt{S_{sum}^2 - P_{sum}^2})$	
3P4W (balance)	$Q_{sum}(=Q \times 3)$	
3P4W (unbalance)	$Q_{sum}(=Q_1+Q_2+Q_3)$ * Q_n : Reactive power at the nth measurement	

Power factor (PF)

Effective input range	Same as the active power
Display range	-1.000 to 0.000 to 1.000
Accuracy	±1dgt to the result determined by each measured value * ±2dgt when measuring balance 3P3W, ±3dgt when measuring balance 3P4W
Polarity sign	Phase delay: no sign, Phase advance: -
Formula	$PF = \left \frac{P}{S} \right $; however, $PF = \cos(\theta)$ only when balance 3P3W * In case of Three-phase circuit, determined by sum value. * Nothing is displayed where $S=0$. * Polarity sign appears based on the voltage-current phase difference (θ). 0° to -90° to 180° : No sign (+) Phase delay 0° to $+90^\circ$ to 180° : Negative (-) Phase advance * Average value is determined by averaging the amount of advance and delay, based on $PF=1$ as reference. [Example] Where measured value is $PF=0.99, -0.92, \text{ and } +0.96$: difference between 0.99 and $1 = -0.01$ (advance), difference between -0.92 and $1 = +0.08$ (delay), and difference between 0.96 and $1 = -0.04$ (advance). The total difference will be $-0.01+0.08+(-0.04)=0.03$ (delay). Then divide the value by 3 (number of measurement): $0.03 \div 3 = 0.01$ (delay). The average PF is 0.01 behind to 1 (PF average value); therefore, -0.99 (advance) will be the average PF.

Voltage current phase difference (θ) [deg] (at Single-phase 2-wire measurement only)

Display range	-180.0 to .00 to 179.9 The LCD shows "----" when readings are out of the display range of active power.
Polarity sign	Phase delay: no sign, Phase advance: -
Measurement method	Compare current waveform against voltage waveform with zero-cross position. * When $S=0$, nothing is displayed. * Polarity sign indicates current phase angle with the voltage phase as reference (0°). No sign (+) Phase advance Negative (-) Phase delay

Harmonics function

Measurement method	Frequency fixed sampling Perform sampling 256 times per input cycle (50/ 60 Hz) and do FFT calculation. Sampling frequency changes depending on the preset nominal frequency. 50Hz...12.8ksps(every 78µs), 60Hz...15.4ksps(every 65µs)
Connect to	L=V ₁ , N=V ₃ , L/ R/ S/ T (clamp onto power wires) = A
Effective frequency	50/ 60 Hz
Analysis order	1st to 30th order
Window width	1 cycle
Window type	Rectangular
Number of analysis data	256 points
Analysis rate	Once/ 500 ms

Harmonics RMS voltage (Vk: 1st fundamental wave to 30th harmonics) [Vrms]

Range, Display digit, effective input range	Same as the RMS voltage
Display range	Same as the RMS voltage *Content rate 0.0% to 100.0% against fundamental wave
Accuracy	RMS: 1 to 10 th : ±5.0%rdg±10dgt 11 to 20 th : ±10%rdg±10dgt 21 to 30 th : ±20%rdg±10dgt Content range: ±1 against the calculated results of each order.
Formula	To connect L=V ₁ , N=V ₃ : $V_k = \sqrt{(V_{kr})^2 + (V_{ki})^2}$ k : Harmonics order Vr : Real number after voltage FFT conversion Vi : Imaginary number after voltage FFT conversion * Content rate = $\frac{V_k \times 100}{V_1(\text{Fundamental wave})}$

Harmonics RMS current (Ak: 1st fundamental wave to 30th harmonics) [Arms]

Range, Display digit, effective input range	Same as the RMS current	
Display range	Same as the RMS current *Content rate 0.0% to 100.0% against fundamental wave	
Accuracy	RMS: 1 to 10 th : ±5.0%rdg±10dgt 11 to 20 th : ±10%rdg±10dgt 21 to 30 th : ±20%rdg±10dgt Content range: ±1 against the calculated results of each order.	
Formula	$Ak = \sqrt{(Akr)^2 + (Aki)^2}$	k : Harmonics order Ar : Real number after current FFT conversion Ai : Imaginary number after current FFT conversion
	* Content rate = $\frac{Ak \times 100}{A1(\text{Fundamental wave})}$	

Total harmonics voltage distortion factor (V THD-F) [%]

Display digit	4-digit	
Display range	0.0% to 100.0%	
Accuracy	±1 against the calculated results of each measured value.	
Formula	$V \text{ THD-F} = \frac{\sqrt{\sum_{k=2}^{30} (Vk)^2} \times 100}{V1(\text{Fundamental wave})}$	V : Harmonics voltage k : Harmonics order

Total harmonics current distortion factor (A THD-F) [%]

Display digit	4-digit	
Display range	0.0% to 100.0%	
Accuracy	±1 against the calculated results of each measured value.	
Formula	$A \text{ THD-F} = \frac{\sqrt{\sum_{k=2}^{30} (Ak)^2} \times 100}{A1(\text{Fundamental wave})}$	A : Harmonics current k : Harmonics order

Total harmonics voltage distortion factor (V THD-R) [%]

Display digit	4-digit
Display range	0.0% to 100.0%
Accuracy	±1 against the calculated results of each measured value.
Formula	$V \text{ THD-R} = \sqrt{\frac{\sum_{k=2}^{30} (V_k)^2 \times 100}{\sum_{k=1}^{30} (V_k)^2}}$ <p>V : Harmonics voltage k : Harmonics order</p>

Total harmonics current distortion factor (A THD-R) [%]

Display digit	4-digit
Display range	0.0% to 100.0%
Accuracy	±1 against the calculated results of each measured value.
Formula	$A \text{ THD-R} = \sqrt{\frac{\sum_{k=2}^{30} (A_k)^2 \times 100}{\sum_{k=1}^{30} (A_k)^2}}$ <p>A : Harmonics current k : Harmonics order</p>

Phase detection function 

Effective input range	RMS voltage (ACV) 80 to 1100 V when measured waveform is 45 to 65 Hz sine wave. If there's no phase differences between each voltage phases, differences of voltage amplitude within 10% If phase voltage is balanced, phase difference: 3P4W (Three-phase 4-wire) within ±30° 3P3W (Three-phase 3-wire) within ±15°	
Display	(1.2.3) Discontinuous buzzer: Pi, Pi, Pi (3.2.1) Continuous: Pii (-.-) No buzzer sounds	: Positive phase, all phases live : Negative phase, all phases live : Unjudgeable Missing phase, abnormal Frequency, out of voltage effective input range, unbalance

Distributor

Kyoritsu reserves the rights to change specifications or designs described in this manual without notice and without obligations.



**KYORITSU ELECTRICAL
INSTRUMENTS
WORKS, LTD.**

2-5-20, Nakane, Meguro-ku,

Tokyo, 152-0031 Japan

Phone: +81-3-3723-0131

Fax: +81-3-3723-0152

Factory: Ehime, Japan

www.kew-ltd.co.jp